

TC70 USER GUIDE

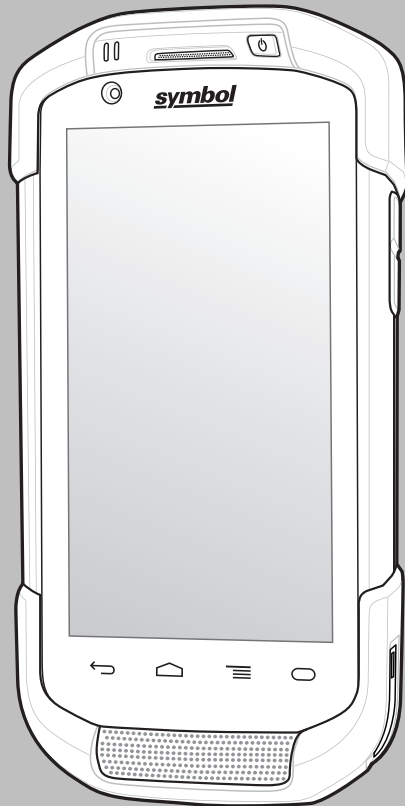

Copyrights

The products described in this document may include copyrighted computer programs. Laws in the United States and other countries preserve for certain exclusive rights for copyrighted computer programs. Accordingly, any copyrighted computer programs contained in the products described in this document may not be copied or reproduced in any manner without the express written permission.

© 2016 Symbol Technologies LLC. All Rights Reserved

No part of this document may be reproduced, transmitted, stored in a retrieval system, or translated into any language or computer language, in any form or by any means, without the prior written permission.

Furthermore, the purchase of our products shall not be deemed to grant either directly or by implication, estoppel or otherwise, any license under the copyrights, patents or patent applications, except for the normal non-exclusive, royalty-free license to use that arises by operation of law in the sale of a product.

Disclaimer

Please note that certain features, facilities, and capabilities described in this document may not be applicable to or licensed for use on a particular system, or may be dependent upon the characteristics of a particular mobile subscriber unit or configuration of certain parameters. Please refer to your contact for further information.

Trademarks

Zebra and the Zebra head graphic are registered trademarks of ZIH Corp. The Symbol logo is a registered trademark of Symbol Technologies LLC.

Revision History

Changes to the original guide are listed below:

Change	Date	Description
A01 Rev. A	10/2014	Initial release.
A02 Rev. A	8/2015	Add support for Google Mobile Services.
A02 Rev. B	2/2016	Correct bracket part number

Contents

Copyrights.....	3
Revision History.....	5
About This Guide.....	13
Documentation Set.....	13
Configurations.....	13
Software Versions.....	13
Chapter Descriptions.....	14
Notational Conventions.....	14
Icon Conventions.....	14
Related Documents.....	15
Service Information.....	15
Chapter 1: Getting Started.....	17
Unpacking.....	17
Features.....	18
Setup.....	20
Installing a microSD Card.....	20
Installing the Hand Strap and Battery.....	21
Installing the Battery.....	22
Charging the Battery.....	23
Charging Indicators.....	24
Google Account Setup.....	24
Replacing the Battery.....	24
Replacing the microSD Card.....	26
Battery Management.....	27
Monitor Battery Usage.....	27
Low Battery Notification.....	28
Battery Optimization.....	29
Turning Off the Radios.....	29
Setting the Date and Time.....	29
Display Setting.....	30
Setting the Screen Brightness.....	30
Setting Screen Rotation.....	30
Setting Screen Timeout Setting.....	30
Setting Font Size.....	31
Setting Touch Key Light.....	31
Touch Mode.....	32
Setting Notification LED.....	33
General Sound Setting.....	33
Wake-Up Sources.....	35
Chapter 2: Using the TC70.....	37
Google Mobile Services.....	37
Home Screen.....	37
Status Bar.....	39
Status Icons.....	39
Notification Icons.....	40
Managing Notifications.....	41
Quick Settings.....	41

Application Shortcuts and Widgets.....	42
Adding an Application or Widget to the Home Screen.....	43
Moving Items on the Home Screen.....	43
Removing an App or Widget from the Home Screen.....	43
Folders.....	43
Creating a Folder.....	43
Naming Folders.....	43
Removing a Folder.....	44
Home Screen Wallpaper.....	44
Changing the Home Screen Wallpaper.....	44
Using the Touchscreen.....	44
Using the On-screen Keyboard.....	45
Applications.....	45
Accessing Applications.....	49
Switching Between Recent Applications.....	50
Un-Locking the Screen.....	51
Single User Mode.....	51
MultiUser Mode.....	54
MultiUser Login.....	54
MultiUser Logout.....	55
Resetting the Device.....	55
Performing a Soft Reset.....	55
Performing a Hard Reset.....	55
Suspend Mode.....	56

Chapter 3: Applications.....59

File Browser.....	59
People.....	60
Adding People.....	60
Editing People.....	60
Deleting People.....	60
Camera.....	61
Taking Photos.....	61
Taking a Panoramic Photo.....	63
Recording Videos.....	64
Photo Settings.....	66
Video Settings.....	68
Gallery.....	69
Working with Albums.....	70
Share an Album.....	71
Get Album Information.....	71
Deleting an Album.....	72
Working with Photos.....	72
Viewing and Browsing Photos.....	72
Cropping a Photo.....	73
Setting a Photo as a Contact Icon.....	74
Share a Photo.....	74
Deleting a Photo.....	75
Working with Videos.....	75
Watching Videos.....	75
Sharing a Video.....	76
Deleting a Video.....	76
DataWedge Demonstration.....	77
Sound Recorder.....	78
PTT Express Voice Client.....	78

Enabling PTT Communication.....	80
Selecting a Talk Group.....	80
PTT Communication.....	80
Creating a Group Call.....	81
Disabling PTT Express Voice Client Communication.....	82
MLog Manager.....	82
SimulScan Demo.....	83
Exporting Sample Forms.....	83
Postal, Transportation and Logistics Example.....	83
Manufacturing Example.....	85
Settings.....	86
Demo Customization.....	87
RxLogger.....	87
Elemez.....	88
Disabling Elemez Data Collection.....	89
Enabling Elemez Data Collection.....	89
Chapter 4: Data Capture.....	91
Imaging.....	91
RS507 Hands-Free Imager.....	91
Scanning Considerations.....	92
Imager Scanning.....	92
Bar Code Capture with RS507 Hands-Free Imager.....	94
Pairing the RS507 Hands-Free Imager Using SSI.....	95
Pairing the RS507 Hands-Free Imager Bluetooth HID.....	96
DataWedge.....	96
Enabling DataWedge.....	96
Disabling DataWedge.....	97
Chapter 5: Wireless.....	99
Wireless Local Area Networks.....	99
Scan and Connect to a Wi-Fi Network.....	99
Configuring a Wi-Fi Network.....	101
Manually Adding a Wi-Fi Network.....	103
Configuring for a Proxy Server.....	103
Configuring the Device to Use a Static IP Address.....	104
Advanced Wi-Fi Settings.....	105
Remove a Wi-Fi Network.....	107
Bluetooth.....	107
Adaptive Frequency Hopping.....	107
Security.....	107
Bluetooth Profiles.....	108
Bluetooth Power States.....	108
Bluetooth Radio Power.....	109
Enabling Bluetooth.....	109
Disabling Bluetooth.....	109
Discovering Bluetooth Device(s).....	109
Changing the Bluetooth Name.....	110
Connecting to a Bluetooth Device.....	110
Selecting Profiles on the Bluetooth Device.....	111
Unpairing a Bluetooth Device.....	111
Near Field Communications.....	111
Reading NFC Cards.....	112
Sharing Information Using NFC.....	112

Enterprise NFC Settings.....	113
Data Usage.....	115

Chapter 6: Accessories.....117

Accessories.....	117
2-Slot Charge Only Cradle.....	119
Charging the Device.....	119
Charging the Spare Battery.....	120
Battery Charging.....	121
2-Slot USB/Ethernet Cradle.....	121
Charging the Device.....	122
Charging the Spare Battery.....	123
Battery Charging.....	124
USB/Ethernet Communication.....	125
Establishing Ethernet Connection.....	126
5-Slot Charge Only Cradle.....	126
Charging the TC70.....	127
Battery Charging.....	128
5-Slot Ethernet Cradle.....	129
Charging the TC70.....	130
Battery Charging.....	132
Establishing Ethernet Connection.....	132
LED Indicators.....	133
4-Slot Battery Charger.....	133
Charging Spare Batteries.....	133
Battery Charging.....	134
Magnetic Stripe Reader.....	134
Attaching the MSR.....	134
Removing the MSR.....	135
Reading Magnetic Stripe Cards.....	136
2.5 mm Audio Adapter.....	137
Attaching the 2.5 mm Audio Adapter.....	137
Connecting a Headset to the Audio Adapter.....	138
Device with Audio Adapter in Holster.....	139
Removing the 2.5 mm Audio Adapter.....	140
3.5 mm Audio Adapter.....	140
Attaching the 3.5 mm Audio Adapter.....	141
Connecting a Headset to the 3.5 mm Audio Adapter.....	141
Device with 3.5 mm Audio Adapter in Holster.....	142
Removing the 3.5 mm Audio Adapter.....	143
Snap-On USB Cable.....	144
Connecting to TC70.....	144
USB Communication.....	144
Charging the TC70.....	145
Disconnecting from TC70.....	145
Battery Charging.....	146
Charging Cable Cup.....	146
Charging the TC70.....	146
Battery Charging.....	148
Snap-On DEX Cable.....	148
Connecting to TC70.....	149
DEX Communication.....	149
Disconnecting from TC70.....	150
Trigger Handle.....	151
Installing the Trigger Handle Plate.....	151

Inserting the Device into the Trigger Handle..... 152
 Removing the Device from the Trigger Handle..... 153

Chapter 7: Maintenance and Troubleshooting..... 155

Maintaining the TC70..... 155
 Battery Safety Guidelines..... 155
 Cleaning Instructions..... 156
 Cleaning the TC70..... 157
 Connector Cleaning..... 157
 Cleaning Cradle Connectors..... 157
 Troubleshooting..... 158
 TC70..... 158

Chapter 8: Technical Specifications..... 161

TC70..... 161

About This Guide

Introduction

This guide provides information about using the TC70 mobile computer and accessories.



Note: Screens and windows pictured in this guide are samples and can differ from actual screens.

Documentation Set

The documentation set for the TC70 provides information for specific user needs, and includes:



- *TC70 Quick Start Guide* - describes how to get the TC70 up and running.
- *TC70 User Guide* - describes how to use the TC70.
- *TC70 Integrator Guide* - describes how to set up the TC70 and accessories.

Configurations



This guide covers the following configurations:

Configuration	Radios	Display	Memory	Data Capture Options	Operating System
TC70 Professional (without Google Mobile Services (GMS))	WLAN: 802.11 a/b/g/n/d/h/i/k/r WPAN: Bluetooth v4.0 Low Energy	4.7" High Definition (1280 x 720) LCD	1 GB RAM / 8 GB Flash (SLC High Reliability Flash)	2D imager and integrated NFC	Android-based, Android Open-Source Project 4.4.2.
TC70 Standard (with GMS)	WLAN: 802.11 a/b/g/n/d/h/i/k/r WPAN: Bluetooth v4.0 Low Energy	4.7" High Definition (1280 x 720) LCD	1 GB RAM / 8 GB Flash (SLC High Reliability Flash)	2D imager and integrated NFC	Android-based, Android Open-Source Project 4.4.3 with GMS.

Software Versions

To determine the current software versions touch  >  **About phone**.

- **Model number**- Displays the model number.
- **Android version** - Displays the operating system version.
- **Kernel version** - Displays the kernel version number.
- **Build number** - Displays the software build number.

To determine the device serial number touch  >  **About phone** > **Status**.

- **Serial number** - Displays the serial number.

Chapter Descriptions

Topics covered in this guide are as follows:

- *Getting Started on page 17* provides information on getting the TC70 up and running for the first time.
- *Using the TC70 on page 37* provides information for operating the TC70.
- *Applications on page 59* provides information on using applications installed on the TC70.
- *Data Capture on page 91* provides information for capturing bar code data using the imager.
- *Wireless on page 99* provides information on the various wireless options.
- *Accessories on page 117* provides information for using the accessories for the TC70.
- *Maintenance and Troubleshooting on page 155* includes instructions on cleaning and provides troubleshooting solutions for potential problems during TC70 operation.
- *Technical Specifications on page 161* provides the technical specifications for the TC70.

Notational Conventions

The following conventions are used in this document:

- *Italics* are used to highlight the following:
 - Chapters and sections in this and related documents
 - Icons on a screen.
- **Bold** text is used to highlight the following:
 - Dialog box, window, and screen names
 - Drop-down list and list box names
 - Check box and radio button names
 - Button names on a screen.
- Bullets (•) indicate:
 - Action items
 - Lists of alternatives
 - Lists of required steps that are not necessarily sequential
- Sequential lists (for example, lists that describe step-by-step procedures) appear as numbered lists.

Icon Conventions

The documentation set is designed to give the reader more visual clues. The following graphic icons are used throughout the documentation set. These icons and their associated meanings are described below.



Warning: The word WARNING with the associated safety icon implies information that, if disregarded, could result in death or serious injury, or serious product damage.



Caution: The word CAUTION with the associated safety icon implies information that, if disregarded, may result in minor or moderate injury, or serious product damage.



Note: NOTE contains information more important than the surrounding text, such as exceptions or preconditions. They also refer the reader elsewhere for additional information, remind the reader how to complete an action (when it is not part of the current procedure, for instance), or tell the reader where something is located on the screen. There is no warning level associated with a note.

Related Documents

- *TC70 Quick Start Guide*, p/n MN000976Axx.
- *TC70 Regulatory Guide*, p/n MN000977Axx.
- *TC70 Integrator Guide*, p/n MN001152Axx.

For the latest version of this guide and all guides, go to: [Support Central](#).

Service Information

If you have a problem with the equipment, contact Customer Support in the region. Contact information is available at: <http://www.zebra.com/support>.

When contacting support, please have the following information available:

- Serial number of the unit (found on manufacturing label)
- Model number or product name (found on manufacturing label)
- Software type and version number

Figure 1: Manufacturing Label

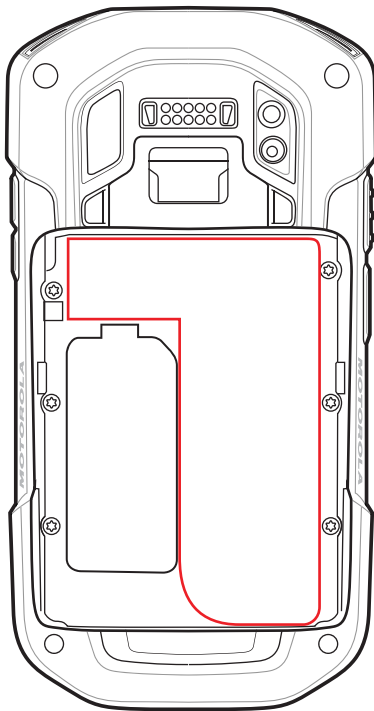

Customer Support responds to calls by email or telephone within the time limits set forth in support agreements.

If the problem cannot be solved by Customer Support, the user may need to return the equipment for servicing and will be given specific directions. We are not responsible for any damages incurred during shipment if the approved shipping container is not used. Shipping the units improperly can possibly void the warranty. Remove the microSD card from the device before shipping for service.

If the device was purchased from a business partner, contact that business partner for support.

Chapter 1

Getting Started

This chapter provides information for getting the device up and running for the first time.

Unpacking

Procedure:

- 1 Carefully remove all protective material from the TC70 and save the shipping container for later storage and shipping.
- 2 Verify that the following were received:
 - TC70 mobile computer
 - 4,620 mAh Lithium-ion battery
 - Hand strap
 - Regulatory Guide
 - Quick Start Guide.
- 3 Inspect the equipment for damage. If any equipment is missing or damaged, contact the Global Customer Support center immediately.
- 4 Prior to using the TC70 for the first time, remove the protective shipping film that covers the scan window, display and camera window.

Features

Figure 2: TC70 Front View

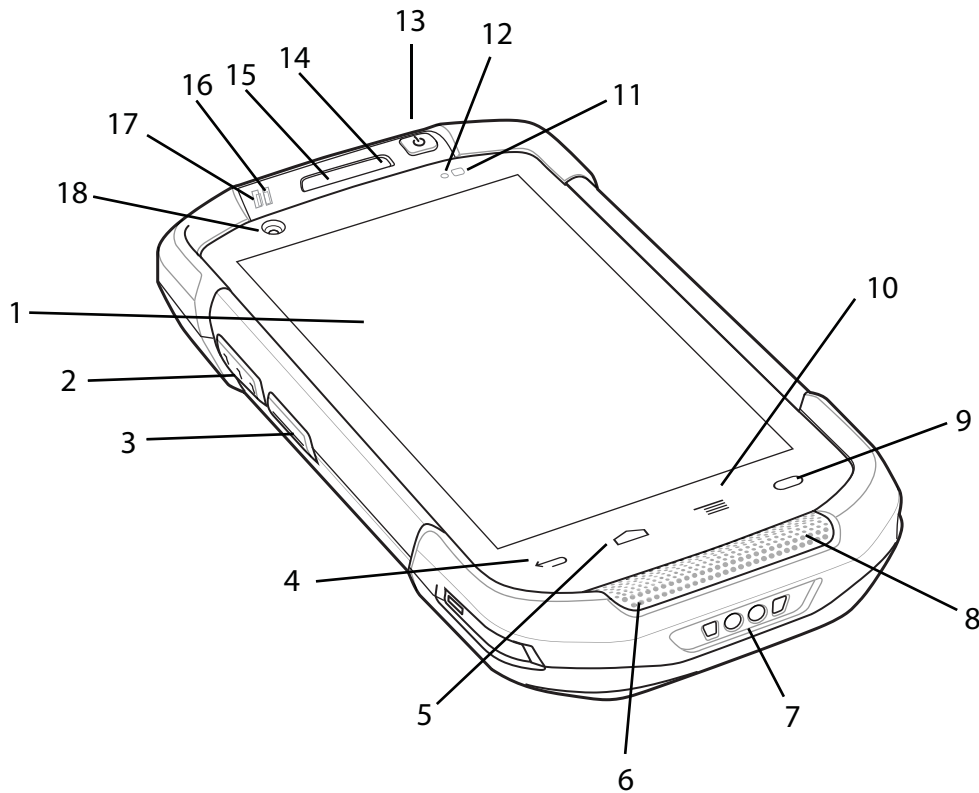

Table 1: Front View Features

Number	Item	Function
1	Touch Screen	Displays all information needed to operate the TC70.
2	PTT Button	Initiates push-to-talk communications (programmable).
3	Scan Button	Initiates data capture (programmable).
4	Back Button	Displays the previous screen.
5	Home Button	Displays the Home screen with a single press. Displays recently used applications when held for a short period of time. On TC70 with GMS, opens the Google Now screen when held for a short period of time.
6	Microphone	Use for communications in Handset mode.
7	Charging Contacts	Provides power to the device from cables and cradles.
8	Speaker	Provides audio output for video and music playback. Provides audio in speakerphone mode.

Table continued...

Number	Item	Function
9	Search Button	Opens the search application (programmable). On TC70 with GMS, opens the Recent App screen.
10	Menu Button	Opens a menu with items that affect the current screen or application.
11	Light Sensor	Determines ambient light for controlling display backlight intensity.
12	Proximity Sensor	Determines proximity for turning off display when in handset mode.
13	Power Button	Turns the display on and off. Press and hold to reset the device or power off.
14	Microphone	Use for communications in Speakerphone mode.
15	Receiver	Use for audio playback in Handset mode.
16	Charging/Notification LED	Indicates battery charging status while charging and application generated notifications..
17	Data Capture LED	Indicates data capture status.
18	Front Facing Camera	Use to take photos and videos.

Figure 3: TC70 Rear View

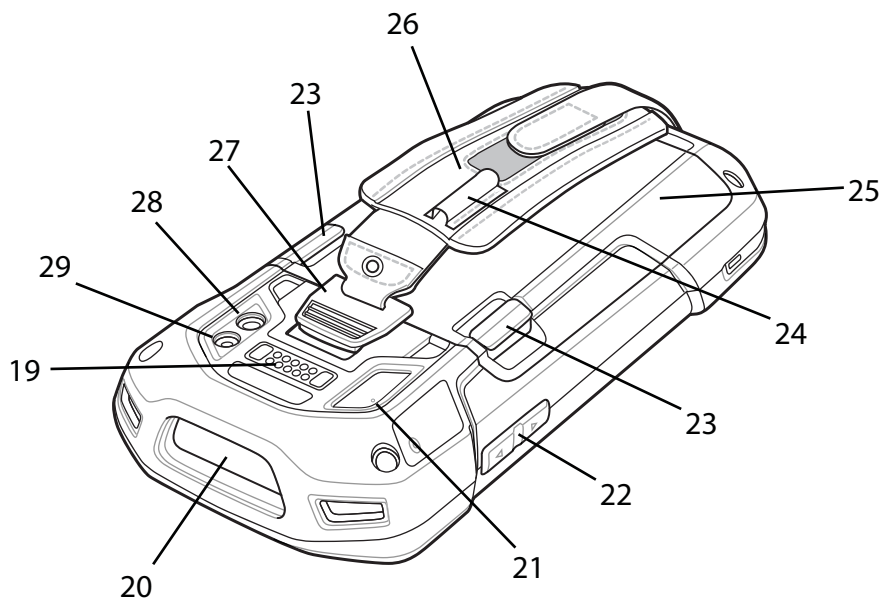

Table 2: Back View Features

Number	Item	Function
19	Interface Connector	Provides USB host and client communications, audio and device charging via cables and accessories.
20	Exit Window	Provides data capture using the imager.
21	Microphone	Use during video recording and for noise cancellation.

Table continued...

Number	Item	Function
22	Volume Up/Down Button	Increase and decrease audio volume (programmable).
23	Battery Release Latches	Press to remove the battery.
24	Elastic Sleeve	Use to hold optional stylus.
25	Battery	Provides power to the device.
26	Hand strap	Use to securely hold the device in your hand.
27	Hand strap Mounting Point	Provides latching point for the hand strap.
28	Camera	Takes photos and videos.
29	Camera Flash	Provides illumination for the camera.

Setup

When and where to use: Perform this procedure to start using the TC70 for the first time.

Procedure:

- 1 Install a micro secure digital (SD) card (optional).
- 2 Install hand strap (optional).
- 3 Install the battery.
- 4 Charge the TC70.
- 5 Power on the TC70.

Installing a microSD Card

The microSD card slot provides secondary non-volatile storage. The slot is located under the battery pack. Refer to the documentation provided with the card for more information, and follow the manufacturer's recommendations for use.



Caution: Follow proper electrostatic discharge (ESD) precautions to avoid damaging the microSD card. Proper ESD precautions include, but are not limited to, working on an ESD mat and ensuring that the operator is properly grounded.

Procedure:

- 1 Remove the hand strap, if installed.
- 2 Lift the access door.

Figure 4: Lift Access Door

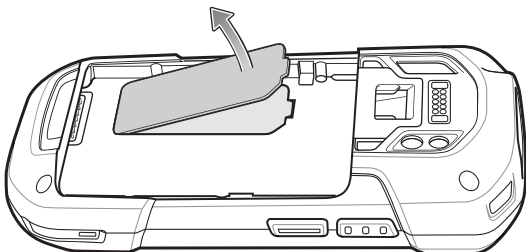

- 3 Insert the microSD card into the card holder door ensuring that the card slides into the holding tabs on each side of the door.
- 4 Re-install the access door.

Installing the Hand Strap and Battery



Note: Installation of the hand strap is optional. Skip this section if not installing the hand strap.

Procedure:

- 1 Remove the hand strap filler from the hand strap slot. Store the hand strap filler in a safe place for future replacement.

Figure 5: Remove Filler

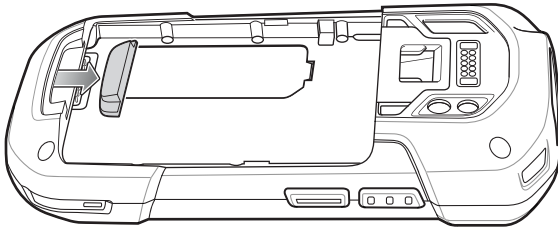

- 2 Insert the hand strap plate into the hand strap slot.

Figure 6: Insert Hand Strap

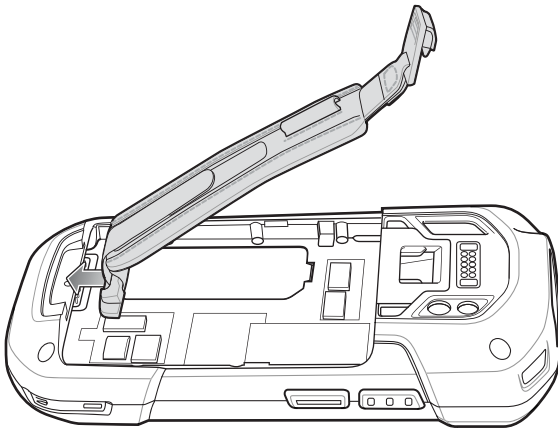

- 3 Insert the battery, bottom first, into the battery compartment in the back of the TC70.

Figure 7: Insert Bottom of Battery into Battery Compartment

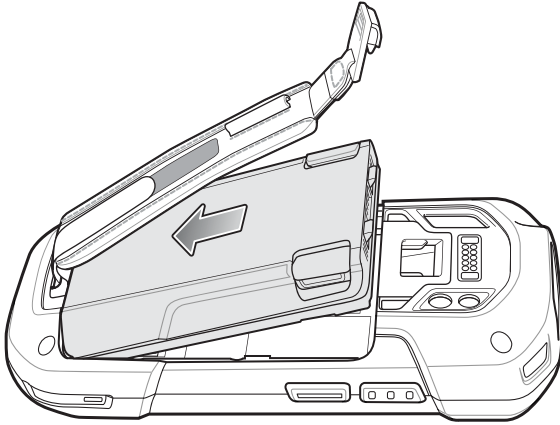

- 4 Rotate the top of the battery into the battery compartment.
- 5 Press the battery down into the battery compartment until the battery release latches snap into place.

Figure 8: Press Down on Battery

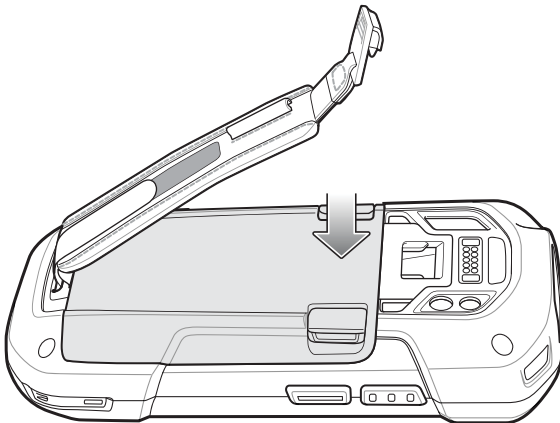

- 6 Place hand strap clip into hand strap mounting slot and pull down until it snaps into place.

Figure 9: Secure Hand Strap Clip

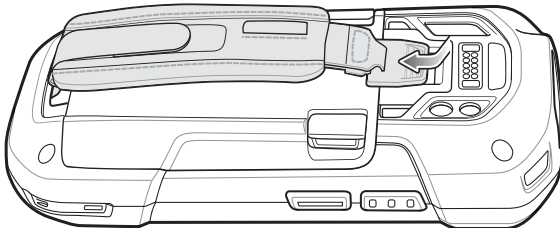

Installing the Battery

Procedure:

- 1 Insert the battery, bottom first, into the battery compartment in the back of the TC70.

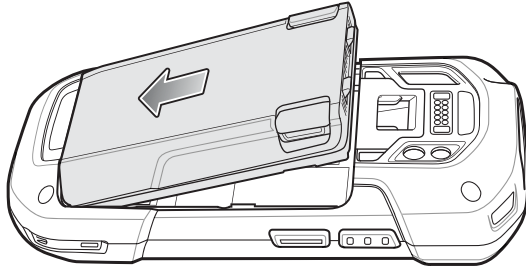
Figure 10: Insert Bottom of Battery into Battery Compartment

- 2 Rotate the top of the battery into the battery compartment.
- 3 Press the battery down into the battery compartment until the battery release latches snap into place.

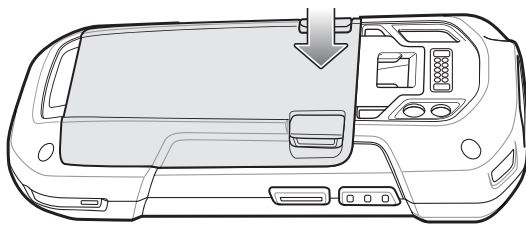
Figure 11: Press Down on Battery

Charging the Battery

Before using the TC70 for the first time, charge the main battery until the green Charging/Notification light emitting diode (LED) remains lit. To charge the TC70, use a cable or a cradle with the appropriate power supply. For information about the accessories available for the TC70, see [Accessories on page 117](#) for more information.

- Snap-On USB Cable
- Charging Cable Cup
- 2-Slot Charge Only Cradle
- 2-Slot USB/Ethernet Cradle
- 5-Slot Charge Only Cradle
- 5-Slot Ethernet Cradle

The 4,620 mAh battery fully charges in approximately six hours at room temperature.

Charge batteries in temperatures from 0 °C to 40 °C (32 °F to 104 °F). The TC70 or accessory always performs battery charging in a safe and intelligent manner. At higher temperatures (e.g. approximately +37 °C (+98 °F)) the TC70 or accessory may for small periods of time alternately enable and disable battery charging to keep the battery at acceptable temperatures. The TC70 or accessory indicates when charging is disabled due to abnormal temperatures via its LED.

Procedure:

- 1 To charge the main battery, connect the charging accessory to the appropriate power source.
- 2 Insert the TC70 into a cradle or attach to a cable. The TC70 turns on and begins charging. The Charging/Notification LED blinks amber while charging, then turns solid green when fully charged.

Charging Indicators

Table 3: Charging/Notification LED Charging Indicators

State	Indication
Off	TC70 is not charging. TC70 is not inserted correctly in the cradle or connected to a power source. Charger/cradle is not powered.
Slow Blinking Amber (1 blink every 2 seconds)	TC70 is charging.
Solid Green	Charging complete.
Fast Blinking Amber (2 blinks/second)	Charging error, e.g.: <ul style="list-style-type: none"> • Temperature is too low or too high. • Charging has gone on too long without completion (typically eight hours).
Slow Blinking Red (1 blink every 2 seconds)	TC70 is charging but the battery is at end of useful life.
Solid Red	Charging complete but the battery is at end of useful life.
Fast Blinking Red (2 blinks/second)	Charging error but the battery is at end of useful life., e.g.: <ul style="list-style-type: none"> • Temperature is too low or too high. • Charging has gone on too long without completion (typically eight hours).

Google Account Setup



Note:

The TC70 has to be connected to the internet, through Wi-Fi, in-order to set up a Google account.

The first time the TC70 starts, the Setup Wizard displays. Follow the on-screen instructions to set up a Google account, configure Google Wallet for purchasing items from the Play Store, entering your personal information, and enabling backup/restore features.

Replacing the Battery



Caution: Do not add or remove SIM, SAM or microSD card during battery replacement.

Procedure:

- 1 Remove any accessory attached to the device.
- 2 Press the Power button until the menu appears.
- 3 Touch **Power off**.
- 4 If hand strap is attached, slide the hand strap clip up toward the top of the TC70 and then lift.

Figure 12: Remove Hand Strap Clip

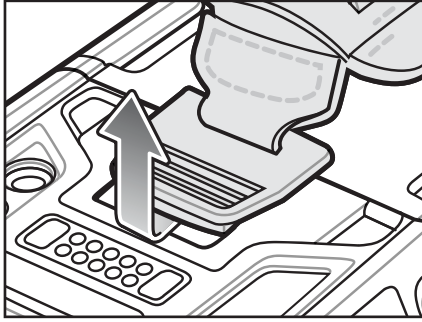

- 5 Press the two battery latches in.

Figure 13: Press Battery Latches

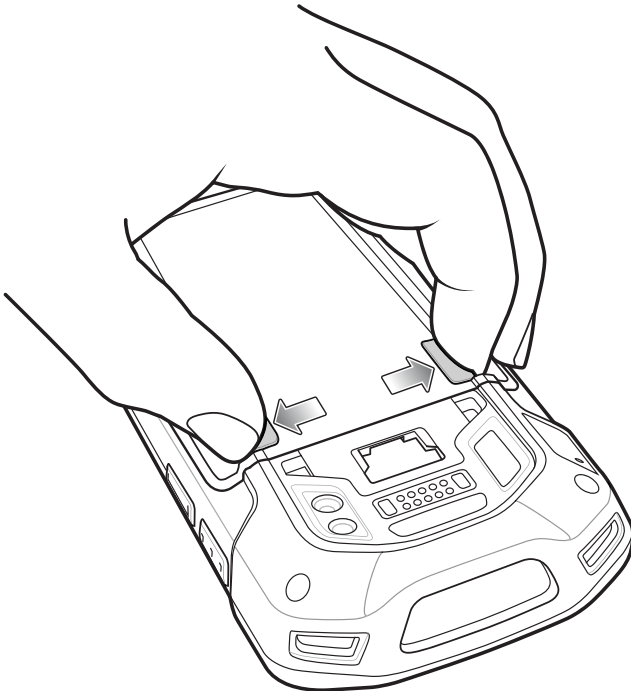

- 6 Lift the battery from the TC70.

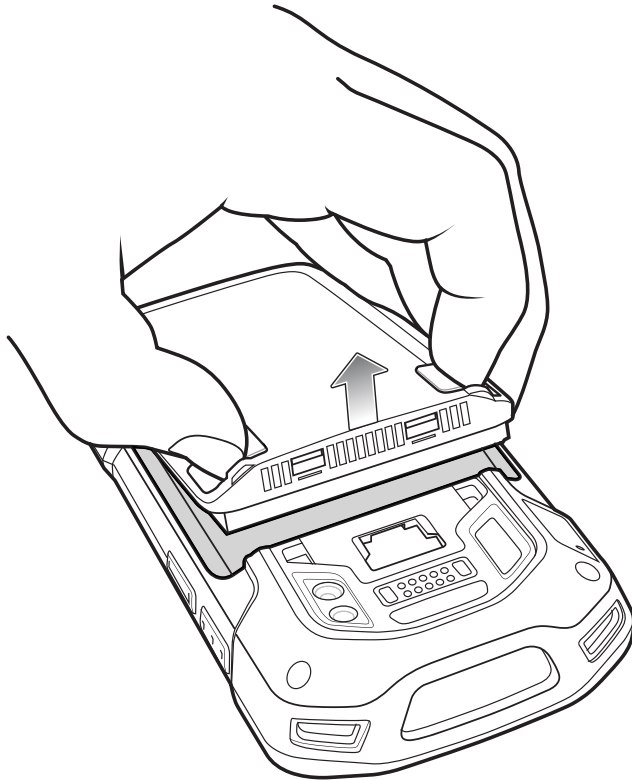
Figure 14: Lift the Battery

- 7 Insert the replacement battery, bottom first, into the battery compartment in the back of the TC70.
- 8 Press the battery down until the battery release latch snaps into place.
- 9 Replace the hand strap, if required.
- 10 Press and hold the Power button to turn on the TC70.

Replacing the microSD Card

Procedure:

- 1 Press the Power button until the menu appears.
- 2 Touch **Power off**.
- 3 If hand strap is attached, slide the hand strap clip up toward the top of the TC70 and then lift.

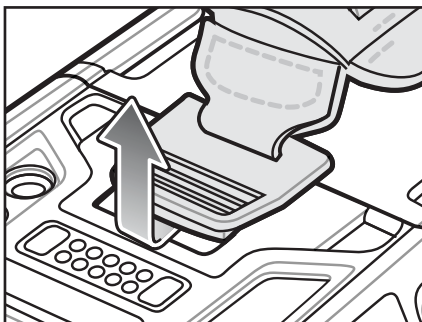
Figure 15: Remove Hand Strap Clip

- 4 Press the two battery latches in.

- 5 Lift the battery from the TC70.
- 6 Lift the access door.

Figure 16: Remove Access Door

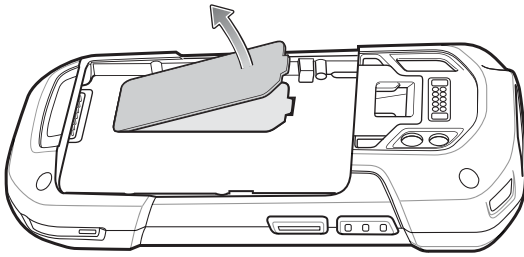

- 7 Remove microSD card from holder.
- 8 Press the access door down and ensure that it is properly seated.
- 9 Insert the replacement microSD card.
- 10 Replace the access door.

Figure 17: Replace Access Door

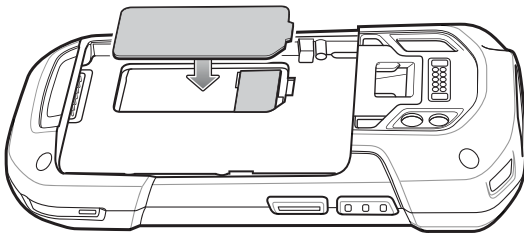



- 11 Insert the battery, bottom first, into the battery compartment in the back of the TC70.
- 12 Press the battery down until the battery release latch snaps into place.
- 13 Replace the hand strap, if required.
- 14 Press and hold the Power button to turn on the TC70.

Battery Management



Note:

Prior to checking the battery charge level, remove the TC70 from any AC power source (cradle or cable).

To check the charge status of the main battery, on the Home screen touch  >  >  **About phone** > **Battery Management**.

Battery status indicates that the battery is discharging and **Battery level** lists the battery charge (as a percentage of fully charged).

Monitor Battery Usage

The **Battery** screen lists which applications consume the most battery power. Also use it to turn off applications that were downloaded if they are consuming too much power.

Touch  >  > **Battery**.

Figure 18: Battery Screen

The **Battery** screen lists the applications using the battery. The discharge graph at the top of the screen shows the rate of the battery discharge since last charged (short periods of time when connected to a charger are shown as thin green lines at the bottom of the chart), and how long it has been running on battery power.

Touch an application in the **Battery** screen to display details about its power consumption. Different applications display different information. Some applications include buttons that open screens with settings to adjust power use.

Low Battery Notification

When the battery charge level drops below 18%, the TC70 displays a notice to connect the TC70 to power. The user should charge the battery using one of the charging accessories.

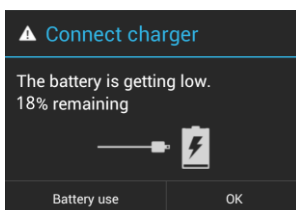
Figure 19: Low Battery Notification

When the battery charge drops below 10%, the TC70 displays a notice to connect the TC70 to power. The user must charge the battery using one of the charging accessories.

When the battery charge drops below 4%, the TC70 turns off.

The user must charge the TC70 using one of the charging accessories.

Battery Optimization

Observe the following battery saving tips:

- Set the screen to turn off after a short period of non-use. See [Setting Screen Timeout Setting on page 30](#).
- Reduce screen brightness. See [Setting the Screen Brightness on page 30](#).
- Turn off all wireless radios when not in use.
- Turn off automatic syncing for Email, Calendar, Contacts and other applications.
- Use the **Power Control** widget to check and control the status of radios, the screen brightness, and syncing.
- Minimize use of applications that keep the TC70 from suspending, for example, music and video applications.

Turning Off the Radios





Procedure:

- 1 Press the Power button until the menu appears.
- 2 Touch **Airplane mode**. The airplane icon  appears in the Status bar indicating that all the radios are off.

Setting the Date and Time

The user is only required to set the time zone or set the date and time when the wireless LAN does not support Network Time Protocol (NTP).

Procedure:

- 1 On the Home screen, touch .
- 2 Touch .
- 3 Touch  **Date & time**.
- 4 Touch **Automatic date & time** to disable automatic date and time synchronization.
- 5 Touch **Set date**.
- 6 Move the sliders up and down to select the month, date and year.
- 7 Touch **Done**.
- 8 Touch **Set time**.
- 9 Move the sliders up and down to select the hour, minutes and part of the day.
- 10 Touch **Done**.
- 11 Touch **Select time zone**.
- 12 Select the current time zone from the list.
- 13 Touch .

Display Setting

Use Display settings to change the screen brightness, change the background image, enable screen rotation, set sleep time and change font size.

Setting the Screen Brightness

To set the screen brightness:

Procedure:





- 1 Touch .
- 2 Touch .
- 3 Touch  **Display**.
- 4 Touch **Brightness**.

Figure 20: Brightness Dialog Box





- 5 In the **Brightness** dialog box, touch **Auto** to set the TC70 to automatically adjust the brightness using the built-in light sensor. Deselect **Auto** to set the brightness manually. Use the slider to set a brightness level.
- 6 Touch .

Setting Screen Rotation

By default, screen rotation is disabled. To enable screen rotation:

Procedure:

- 1 On the Home screen, touch .
- 2 Touch .
- 3 Touch  **Display**.
- 4 Check **Auto-rotate screen** to set the TC70 to automatically switch orientation when the TC70 is rotated.



Note:



The Home screen does not rotate.

- 5 Touch .

Setting Screen Timeout Setting

To set the screen sleep time:

Procedure:

- 1 On the Home screen, touch .
- 2 Touch .
- 3 Touch  **Display**.
- 4 Touch **Sleep**.

5 Select one of the sleep values.

- **15 seconds**
- **30 seconds**
- **1 minute** (default)
- **2 minutes**
- **5 minutes**
- **10 minutes**
- **30 minutes**

6 Touch .

Setting Font Size

To set the size of the font in system applications:

Procedure:

1 Touch .

2 Touch .

3 Touch  **Display**.

4 Touch **Font size**.

5 Select one of the font size values.

- **Small**
- **Normal** (default)
- **Large**
- **Huge**

6 Touch .

Setting Touch Key Light

The four touch keys under the screen are backlit. Configure the touch key light to save battery power.

Procedure:

1 Touch .

2 Touch .

3 Touch  **Display**.

4 Touch **Touch key light**.

5 Select one of the options.

- **Always off** - The touch key light is off.
- **6 seconds** - The touch key light stays on for six seconds and then turns off (default).
- **10 seconds** - The touch key light stays on for 10 seconds and then turns off.
- **15 seconds** - The touch key light stays on for 15 seconds and then turns off.
- **30 seconds** - The touch key light stays on for 30 seconds and then turns off.
- **1 minute** - The touch key light stays on for one minute and then turns off.
- **Always on** - The touch key light is on when the screen is on.

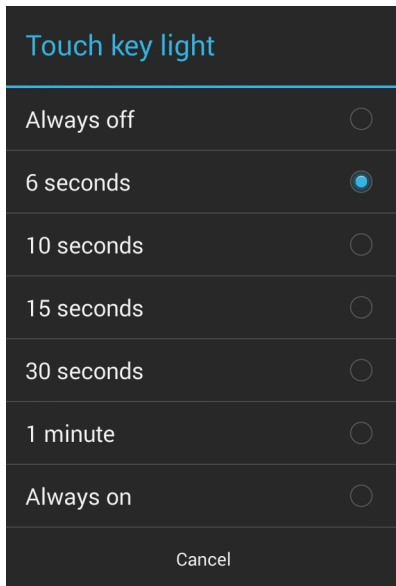
Figure 21: Touch Key Light Dialog Box

- 6 Touch .

Touch Mode

The TC70 display is able to detect touches using a finger, a conductive-tip stylus or gloved finger.



Note:

A glove can be made of medical latex, leather, cotton or wool.

For optimal performance use Zebra certified stylus.

Procedure:





- 1 Touch .
- 2 Touch .
- 3 Touch  **Display**.
- 4 Touch **Touch Mode**.



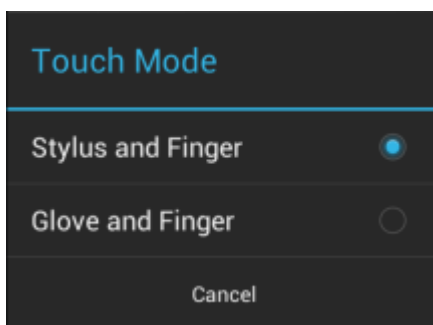

Figure 22: Touch Mode Dialog Box

- 5 Touch **Stylus and Finger** to use a finger or a stylus on the screen or touch **Glove and Finger** to use a finger or a gloved finger on the screen.
- 6 Touch .



Setting Notification LED

The Charging/Notification LED lights blue when an application, such as email and VoIP, generates a programmable notification or to indicate when the TC70 is connected to a Bluetooth device. By default, LED notifications are enabled. To change the notification setting:

Procedure:

- 1 On the Home screen, touch .
- 2 Touch .
- 3 Touch  **Display**.
- 4 Touch **Pulse notification light** to toggle the notification on or off.
- 5 Touch .

General Sound Setting

Use the **Sounds** settings to configure media and alarm volumes. On the Home screen, touch  >  >  **Sounds**.



Alternately, touch the Status bar and drag down to open the Notification panel. Touch  >  >  **Sounds**.

Figure 23: Sounds Screen



- **Volumes** – Use to change the volume of media, ringtones, notifications and alarms.

Figure 24: Volumes Dialog Box

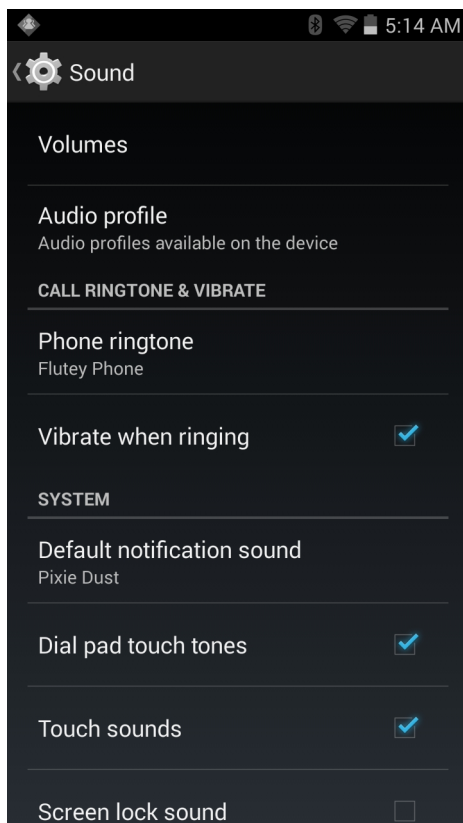
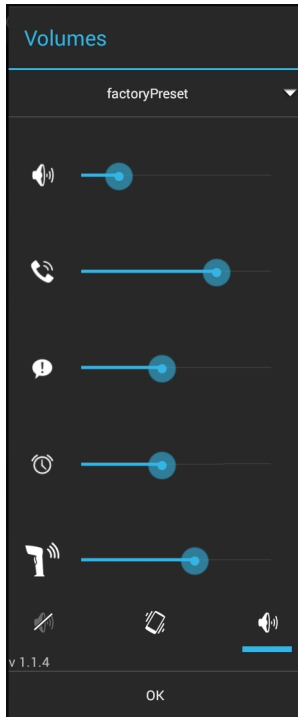







-  - Controls the music and media volume.
-  - Controls the ringtone volume.
-  - Controls the system notification volume.
-  - Controls the alarm clock volume.
-  - Controls the scan good decode beep volume.
- Bottom row icons:
 - +  - Places all sounds except media and alarms in silence mode.
 - +  - Places all sounds except media and alarms in vibrate mode.
 - +  - Places all sounds in sound mode.
- **Audio profile** – Touch to set audio profile. On the **Audio profile** screen, touch **Audio profile**.

Figure 25: Audio Profile Dialog Box

- **General** – Standard audio settings (default).
- **increased clarity** – Increased volume on higher frequencies.
- **Call Ringtone and Vibrate**
 - **Phone ringtone** - Touch to select a ringtone to sound when an incoming call is received.
 - **Vibrate when ringing** - Check to make the device vibrate when a call is received (default – enabled).
- **System**
 - **Default notification** - Touch to select a sound to play for all system notifications.
 - **Dial pad touch tones** - Check to play a sound when a phone key is touched (default – enabled).
 - **Touch sounds** - Check to play a sound when making screen selections (default – enabled).
 - **Screen lock sounds** - Check to play a sound when locking and unlocking the screen (default – disabled).
 - **Vibrate on touch** - Check to have the device vibrate when touching soft keys and on certain screen interactions (default – enabled).

Wake-Up Sources

By default the TC70 wakes from suspend mode when the user presses the power button. The TC70 can be configured to wake when the user presses the PPT or Scan buttons on the left side of the device.

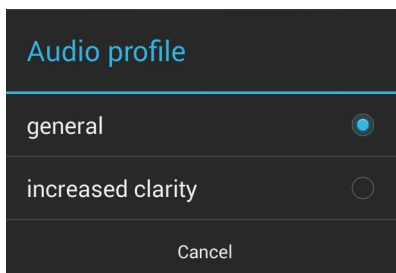
Procedure:





- 1 Touch .
- 2 Touch  **Wake-Up Sources**.
- 3 Touch **Keypad** checkbox. A blue check appears in the checkbox.

Figure 26: Wake-Up Sources Dialog Box

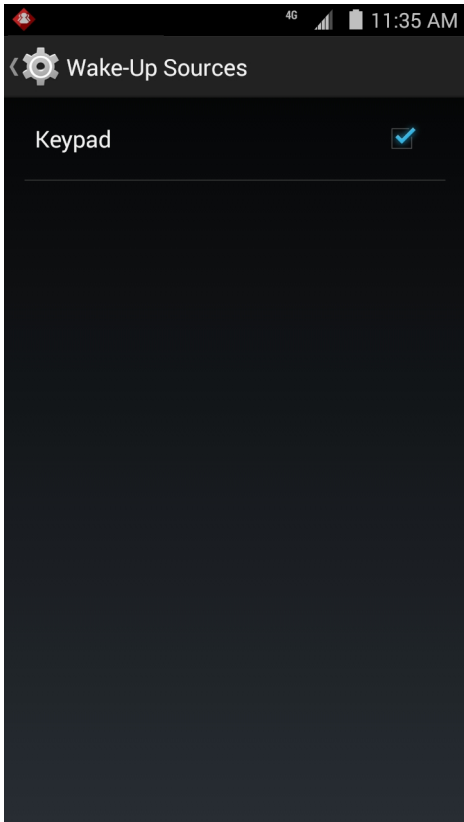

4 Touch .

Chapter 2

Using the TC70

Introduction

This chapter explains the buttons, status icons, and controls on the TC70, and provides basic instructions for using the TC70, including resetting the TC70 and entering data.

Google Mobile Services



Note: This section only applies to TC70 configurations with Google Mobile Services (GMS).

The TC70 with GMS contains applications and services that provide additional functionality to the TC70.

GMS includes:

- **Applications** - GMS adds a variety of Google applications and associated widgets including Chrome, Gmail, Drive and Maps.
- **Services:**
 - **Speech to Text** - Allows for free format speech to text, in many languages for both connected and disconnected network. Launch by touching the microphone icon on the keyboard.
 - **TalkBack Service** - Provides spoken feedback on various parts of the user interface. To enable, go to **Settings > Accessibility**.
 - **Network Location Provider** - Adds a location provider which uses mobile network tower information and Wi-Fi access point information to provide a location without using GPS. To enable, go to **Settings > Location access**.
 - **Widevine DRM** - Enables the digital rights management so that protected content can be played. Enable via DRM Info from the Play Store.
 - **Google Cloud Messaging** - Allows the sending of data from your server to your TC70 and also to receive messages from devices on the same connection.
 - **Backup and Restore** - Allows the users settings and applications to be backed up to a Google server and subsequently restored from that server after a factory reset.
- **Google accounts** - Create and use a Google account to synchronize mail, files, music, photos, contacts and calendar events.

Home Screen

The Home screen displays when the TC70 turns on. Depending upon the configuration, the Home screen might appear different. Contact your system administrator for more information.



After a suspend or screen time-out, the Home screen displays with the lock sliders. Slide  to the right toward  to unlock the screen. For screen locking information see [Un-Locking the Screen on page 51](#).

Figure 27: Home Screen Examples



Table 4: Home Screen Items

Item	Description
1 — Status Bar	Displays the time, status icons (right side), and notification icons (left side). For more information see Status Icons on page 39 and Managing Notifications on page 41 .
2 — Browser Icons	Opens browser application.
3 — All Apps Icon	Opens the APPS window.
4 — Shortcut Icons	Opens applications installed on the TC70. See Application Shortcuts and Widgets on page 42 for more information.
5 — Widgets	Launches stand-alone applications that run on the Home screen. See Application Shortcuts and Widgets on page 42 for more information.

The Home screen provides four additional screens for placement of widgets and shortcuts. Swipe the screen left or right to view the additional screens.

Status Bar

The Status bar displays the time, notification icons (left side) and status icons (right side).

Figure 28: Notification and Status Icons



Table 5: Home Screen Items

Item	Description
1	Notification icons.
2	Status icons.

If there are more notifications than can fit in the Status bar,  displays indicating that more notifications exist. Open the Notifications panel to view all notifications and status.

Status Icons

Table 6: Status Icons













Icon	Description
	Indicates that the Alarm is active.
	Indicates that all sounds except media and alarms are silenced and vibrate mode is active.
	Indicates that all sounds except media and alarms are silenced.
	Indicates that the battery is fully charged.
	Indicates that the battery is partially drained.
	Indicates that the battery charge is low.
	Indicates that the battery charge is very low.
	Indicates that the battery is charging.
	Indicates that the Airplane Mode is active. All radios are turned off.
	Indicates that Bluetooth is on.

Table continued...

Icon	Description
	Indicates that the TC70 is connected to a Bluetooth device.
	Connected to a Wi-Fi network.
	No Wi-Fi signal.

Notification Icons

Table 7: Notification Icons

















Icon	Description
	Indicates that more notifications are available for viewing.
	Indicates that data is syncing.
	Indicates an upcoming event.
	Indicates that an open Wi-Fi network is available.
	Indicates that a song is playing.
	Indicates that a problem with sign-in or sync has occurred.
	Indicates that the TC70 is uploading data.
	Indicates that the TC70 is downloading data when animated and download is complete when static.
	Indicates that the TC70 is connected via USB cable.
	Indicates that the TC70 is connected to or disconnected from virtual private network (VPN).
	Preparing SD card.
	Indicates that USB debugging is enabled on the TC70.
	Indicates that the MultiUser feature is enabled. Appears only when MultiUser Administrator application is installed.
	Indicates that a new user is logging in. Appears only when MultiUser Administrator application is installed.
	Indicates the status of the PTT Express Voice Client. See Notification Icons on page 80 for complete list of PTT Express notification icons.

Table continued...

Icon	Description
	Indicates that DataWedge application is running on the device.

Managing Notifications

Notification icons report the arrival of new messages, calendar events, and alarms, as well as ongoing events. When a notification occurs, an icon appears in the Status bar with a brief description. See [Notification Icons on page 40](#) for a list of possible notification icons and their description. Open the **Notifications** panel to view a list of all the notifications.

To open the Notification panel drag the Status bar down from the top of the screen.

Figure 29: Notification Panel

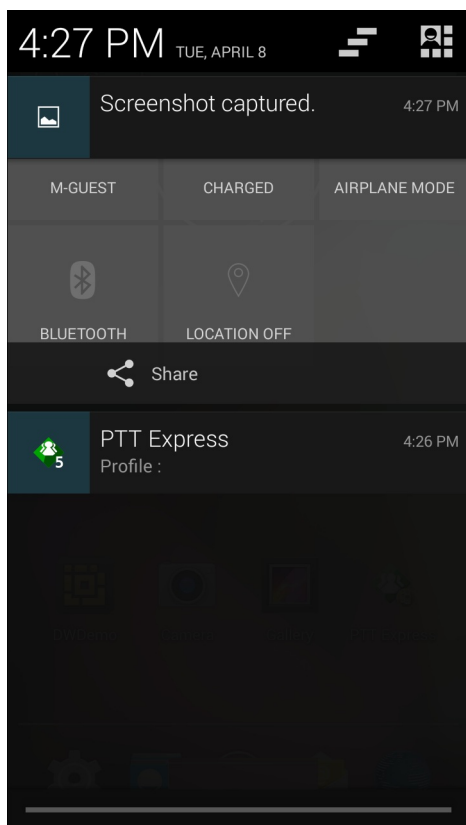

To respond to a notification, open the Notifications Panel and then touch a notification. The Notifications Panel closes and the subsequent activity is dependent on the notification.

To clear all notifications, open the Notifications Panel and then touch . All event-based notifications are removed. Ongoing notifications remain in the list.

Touch  to open the Quick Settings screen.

To close the Notification Panel, drag the bottom of the Notifications Panel to the top of the screen or touch .

Quick Settings

The Quick Settings panel provides easy access to some frequently used settings.

Drag the Status bar down from the top of the screen. The Quick Settings icon displays in the top right corner. Touch



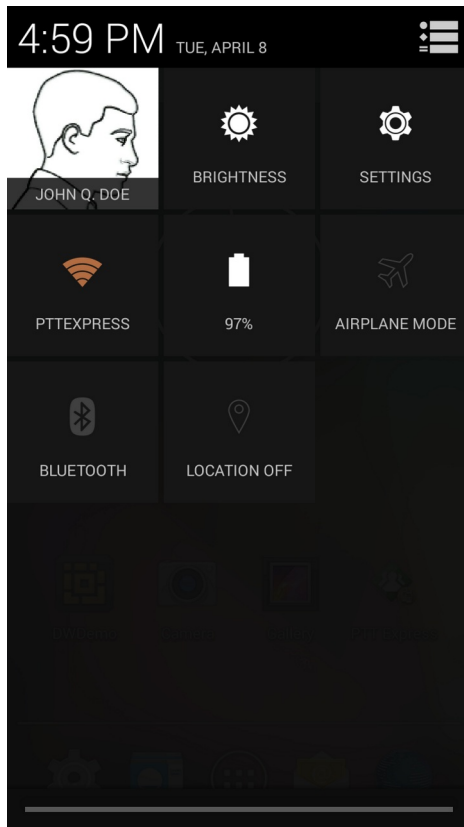

to display the **Quick Settings** panel.

Figure 30: Quick Settings



- **Owner** – Display the owner’s contact image. Touch to open the owner’s contact information. User must first set up contact information in **People** application.
- **Brightness** – Opens the Brightness setting dialog box to set the screen brightness.
- **Settings** – Opens the **Settings** screen.
- **Wi-Fi** – Displays the current Wi-Fi connection. Touch to opens the **Wi-Fi** settings screen.
- **Battery** – Displays the current battery charge level. Touch to opens the **Battery** screen.
- **Airplane Mode** – Displays the Airplane mode status. Touch to toggle Airplane mode on and off. Turn on Airplane mode to turn off all the radios.
- **Bluetooth** – Displays the current state of the Bluetooth radio. Touch to open the **Bluetooth** settings screen.
- **Location** – Displays the current state of the Location settings. Touch to opens the **Location** settings screen.

To close the Quick Settings Panel, drag the bottom of the Quick Settings Panel to the top of the screen, touch  at the top right corner of the screen or touch .

Application Shortcuts and Widgets

Application shortcuts placed on the Home screen allow quick and easy access to applications. Widgets are self-contained applications placed on the Home screen to access frequently used features.

Adding an Application or Widget to the Home Screen

Procedure:

- 1 Go to the desired Home screen.
- 2 Touch .
- 3 Swipe right, if necessary, to find the application icon or widget.
- 4 Touch and hold the icon or widget until the Home screen appears.
- 5 Position the icon on the screen and then release.

Moving Items on the Home Screen

Procedure:

- 1 Touch and hold the item until it floats on the screen.
- 2 Drag the item to a new location. Pause at the edge of the screen to drag the item onto an adjacent Home screen.
- 3 Lift finger to place the item on the Home screen.

Removing an App or Widget from the Home Screen

Procedure:

- 1 Go to the desired Home screen.
- 2 Touch and hold the application shortcut or widget icon until it floats on the screen.
- 3 Drag the icon to  **Remove** on the top of the screen and then release.

Folders

Use **Folders** to organize similar applications together. Tap the folder to open and display items in the folder.

Creating a Folder

To create a folder, there must be at least two app icons on the Home screen.

Procedure:

- 1 Go to the desired Home screen.
- 2 Touch and hold on one application icon.
- 3 Drag the icon and stack on top of another icon.
- 4 Lift and release.

Naming Folders

Procedure:

- 1 Touch the folder.

Figure 31: Open Folder

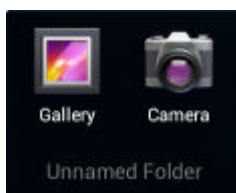

- 2 Touch the title area and enter a folder name using the keyboard.

- 3 Touch **Done** on the keyboard.
- 4 Touch anywhere on the Home screen to close the folder. The folder name appears under the folder.

Figure 32: Renamed Folder



Removing a Folder

Procedure:

- 1 Touch and hold the folder icon until it enlarges.
- 2 Drag the icon to  **Remove** and release.

Home Screen Wallpaper



Note: Use of Live Wallpaper may reduce battery life.

Changing the Home Screen Wallpaper

Procedure:

- 1 Touch .
- 2 Touch **Wallpaper**.
- 3 From the **Choose wallpaper from** menu, touch **Gallery**, **Live wallpapers** or **Wallpapers**.
 - **Gallery** - Select to use an image stored on the device.
 - **Live wallpapers** - Select to use an animated wallpaper image.
 - **Wallpapers** - Select to use a wallpaper image.
- 4 Touch **Save** or **Set wallpaper**.

Using the Touchscreen

Use the multi-tap sensitive screen to operate the device.

- **Tap** - Tap to:
 - select items on the screen
 - type letters and symbols using the on-screen keyboard
 - press on-screen buttons.
- **Tap and Hold** - Tap and hold:
 - an item on the Home screen to move it to a new location or to the trash.
 - an item in Apps to create a shortcut on the Home screen.
 - the Home screen to open a menu for customizing the Home screen.
 - an empty area on the Home screen until the menu appears.
- **Drag** - Tap and hold an item for a moment and then move finger on the screen until reaching the new position.
- **Swipe** - Move finger up and down or left and right on the screen to:
 - unlock the screen

- view additional Home screens
- view additional application icons in the Launcher window
- view more information on an application's screen.
- **Double-tap** - Tap twice on a web page, map, or other screen to zoom in and out.
- **Pinch** - In some applications, zoom in and out by placing two fingers on the screen and pinching them together (to zoom out) or spreading them apart (to zoom in).

Using the On-screen Keyboard

Use the on-screen keyboard to enter text in a text field. To configure the keyboard settings, touch and hold 



(comma) >  and then select **Android keyboard settings**.

Editing Text

Edit entered text and use menu commands to cut, copy, and paste text within or across applications. Some applications do not support editing some or all of the text they display; others may offer their own way to select text.

Entering Numbers, Symbols and Special Characters

To enter numbers and symbols:

- Touch and hold one of the top-row keys until a menu appears then select a number. Keys with alternate characters display an ellipsis (...) below the character.
- Touch and hold the Shift key with one finger, touch one or more capital letters or symbols to enter them, and then lift both fingers to return to the lowercase keyboard.
- Touch  to switch to the numbers and symbols keyboard.
- Touch the  key on the numbers and symbols keyboard to view additional symbols.

To enter special characters, touch and hold a number or symbol key to open a menu of additional symbols.

- A larger version of the key displays briefly over the keyboard.
- Keys with alternate characters display an ellipsis (...) below the character.

Applications

The **APPS** screen displays icons for all installed applications. The table below lists the applications installed on the TC70. Refer to the *TC70 Integrator Guide* for information on installing and uninstalling application.

Table 8: Applications



Icon	Description
 	AppGallery - Provides links to utilities and demonstration applications that can be installed on the TC70.

Table continued...





Icon	Description
	Bluetooth Pairing Utility – Use to pair the RS507 Hans-free Imager with the TC70 by scanning a bar code.
	Browser - Use to access the Internet or intranet. TC70 Professional (without GMS) only.
	Calculator - Provides the basic and scientific arithmetic functions.
	Calendar - Use to manage events and appointments.
	Camera - Take photos or record videos. For more information see Camera on page 61 .
	Chrome - Use to access the Internet or intranet. TC70 Standard (with GMS) only.
	Clock - Use to schedule alarms for appointments or as a wake-up.
	DataWedge - Enables data capture using the imager.
	Downloads - lists all downloads files.
	Drive - Upload photos, videos, documents, and other files to personal storage site. TC70 Professional (with GMS) only.
	DWDemo - Provides a way to demonstrate the data capture features using the imager. See DataWedge Demonstration on page 77 for more information.
 or 	elemz — Use to provide diagnostic information. See Elemz on page 88 for more information.
	Email - Use to send and receive email.
	File Browser - Organize and manage files on the TC70. See File Browser on page 59 for more information.

Table continued...

Icon	Description
	Gallery - Use to view photos stored on the microSD card. For more information, see Gallery on page 69 for more information.
	Gmail - Use to send and receive email using a Google email account. TC70 Standard (with GMS) only.
	Google - Launches Google search application. TC70 Standard (with GMS) only.
	Google Settings - Use to connect applications to Google account, setup Google Plus account, set location settings, set search features and configure Android Device Manager. TC70 Standard (with GMS) only.
	Google+ - Connect with people on Google social network. TC70 Standard (with GMS) only.
	Hangouts - Use to communicate with friends using text messages and photos. TC70 Standard (with GMS) only.
	Maps - Use to see you location on a map (with public transit, traffic or satellite overlays). Search for any business or place of interest. Provides turn-by-turn navigation with voice guidance and traffic-avoidance and alternate routes, for drivers, cyclist, walkers and users of public transportation. TC70 Standard (with GMS) only.
	MLog Manager - Use to capture log files for diagnostics. See MLog Manager on page 82 for more information.
	MobiControl Stage – Opens the MobiControl Stage application to stage the device.
	Movie Studio - Use to create movie videos.
	MSP Agent - Enables management of the TC70 from an MSP server. Requires the purchase of an appropriate MSP client license per device to suit the level of management functionality required.
	MSRN - Use verify authenticity of the paired Snap-on MSR and to provision the Snap-on MSR. See the <i>TC70 Integrator Guide</i> for more information.
	Music - Play music stored on the microSD card. TC70 Professional (without GMS) only.
	People - Use to manage contact information. People on page 60 for more information.

Table continued...























Icon	Description
	Phone - Use to dial a phone number when used with some Voice over IP (VoIP) clients (VoIP telephony ready only).
	Photos - Use to sync photos with Google account. TC70 Standard (with GMS) only.
	Play Books - Use to read books. TC70 Standard (with GMS) only.
	Play Games - Use to play games. TC70 Standard (with GMS) only.
	Play Magazines - Use to subscribe to magazine and read on-line. TC70 without GMS only.
	Play Movies & TV - View movies and video on your device. TC70 Standard (with GMS) only.
	Play Music - Use to listen to music. TC70 Standard (with GMS) only.
	Play Newsstand - Displays current news. TC70 Standard (with GMS) only.
	Play Store - Download music, movies, books, and Android apps and games from the Google Play Store. TC70 Standard (with GMS) only.
	PTT Express - Use to launch PTT Express client for VoIP communication.
	Rapid Deployment - Allows the TC70 to stage a device for initial use by initiating the deployment of settings, firmware and software. Requires the purchase of an MSP client license per device.
	RxLogger - Use to diagnose device and application issues. See the <i>TC70 Integrator Guide</i> for more information.
	Search - Use the Google search engine to search the Internet and the TC70. TC70 Professional (without GMS) only.
	Settings - Use to configure the TC70.

Table continued...

Icon	Description
	SimulScan Demo - Use to demonstrate the document capture feature of the TC70.
	Sound Recorder - Use to record audio. TC70 Professional (without GMS) only.
	StageNow - Allows the TC70 to stage a device for initial use by initiating the deployment of settings, firmware and software.
	TechDocs - Opens the on-device User Guide for the TC70.
	Voice Search - Use to perform searches by asking questions. TC70 Standard (with GMS) only.
	YouTube - Use to view videos on the YouTube web site. TC70 Standard (with GMS) only.
	AppLock Administrator - Use to configure the Application Lock feature. This icon appears after the optional application is installed.
	MultiUser Administrator - Use to configure the MultiUser feature. This icon appears after the optional application is installed.
	Secure Storage Administrator - Use to configure the Secure Storage feature. This icon appears after the optional application is installed.

Accessing Applications

All applications installed on the device are accessed using the **APPS** window.

Procedure:

- 1 On the Home screen, touch .

Figure 33: APPS Window Example



- 2 Slide the **APPS** window left or right to view more application icons. Touch an icon to open the application.



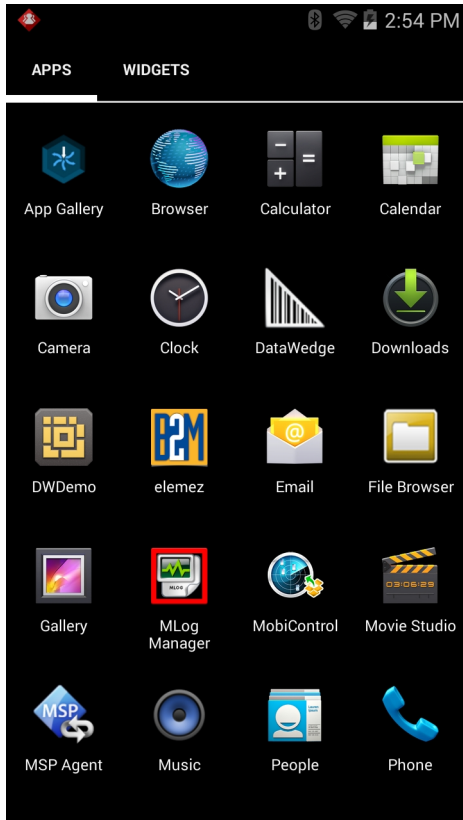

Note: See [Application Shortcuts and Widgets on page 42](#) for information on creating a shortcut on the Home screen.

Switching Between Recent Applications

Procedure:

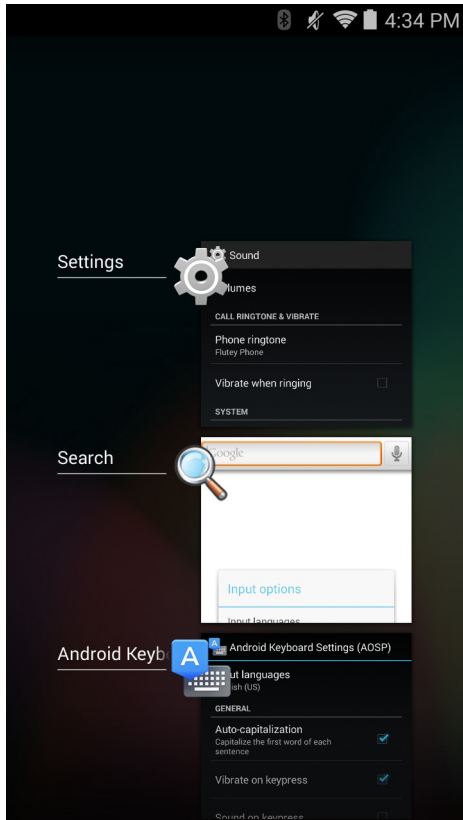
- 1 Touch and hold  (non-GMS devices) or  (GMS devices). A window appears on the screen with icons of recently used applications.

Figure 34: Recently Used Applications

- 2 Slide the window up and down to view all recently used applications.
- 3 Swipe left or right to remove application from the list and force close the application.
- 4 Touch an icon to open it or  to return to the current screen.



Un-Locking the Screen

Use the Lock screen to protect access to data on the TC70. Some email account require locking the screen. Refer to the *TC70 Integrator Guide* for information on setting up the locking feature. The Locking feature functions differently in Single User mode or Multiple User mode.

Single User Mode

When locked, a pattern, PIN or password is required to unlock the device. Press the Power button to lock the screen. The device also locks after a pre-defined time-out.

Press and release the Power button to wake the device.

The Lock screen displays. Slide  to the right toward  to unlock the screen.

If the Pattern screen unlock feature is enabled, the Pattern screen appears instead of the Lock screen.

If the PIN or Password screen unlock feature is enabled, enter the PIN or password after unlocking the screen.

Figure 35: Lock Screen

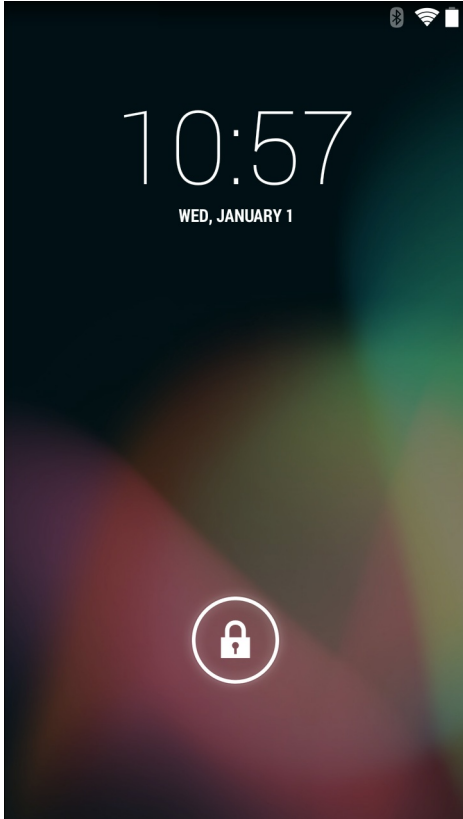

Figure 36: PIN Screen

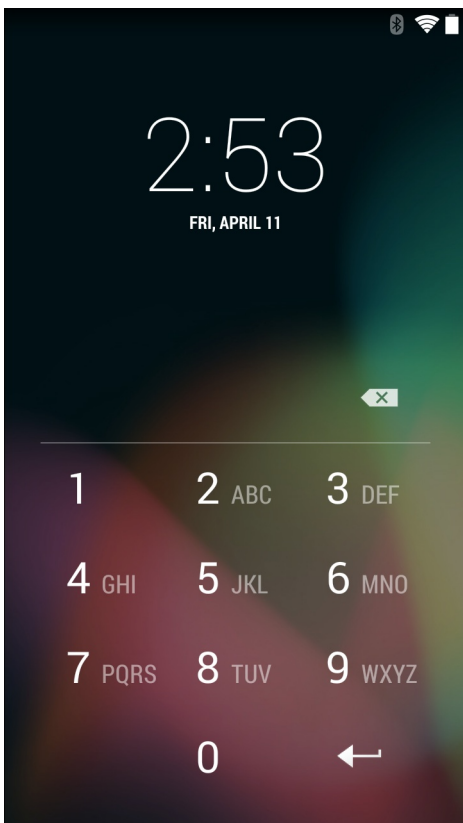

Figure 37: Pattern Screen

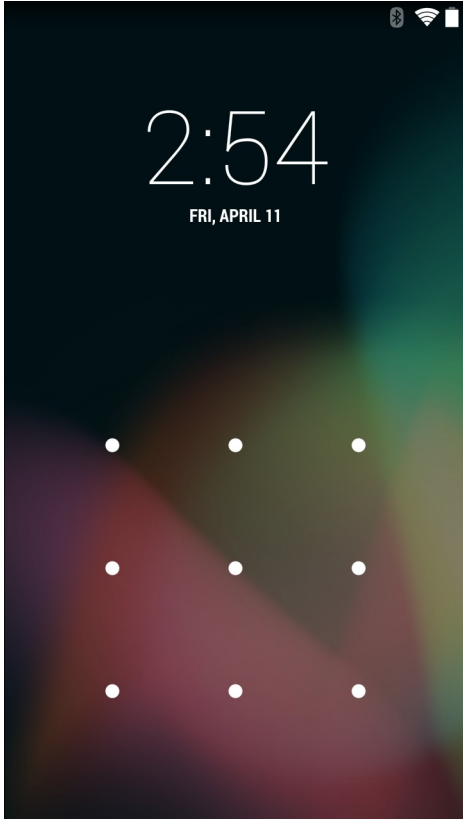
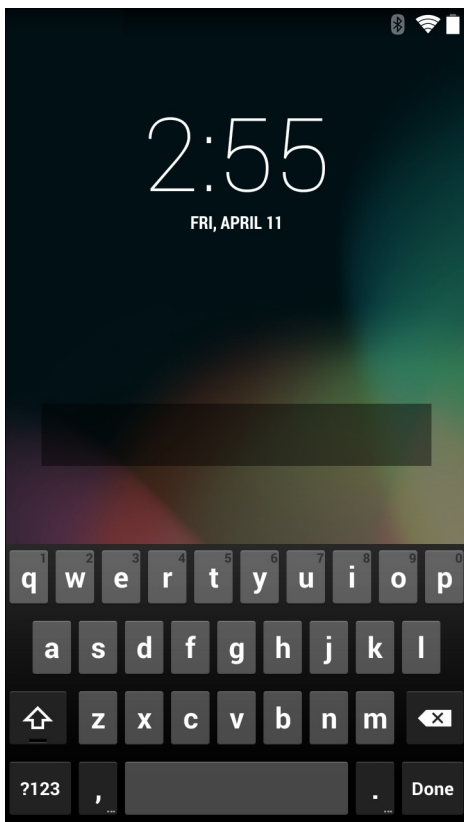

Figure 38: Password Screen

MultiUser Mode

With MultiUser login, multiple users can log on to the device with each user having access to various applications and features. When enabled, the Login screen appears after powering on, resetting or after the device wakes from suspend mode.

MultiUser Login

Procedure:

- 1 In the **Login** text field, enter the username.

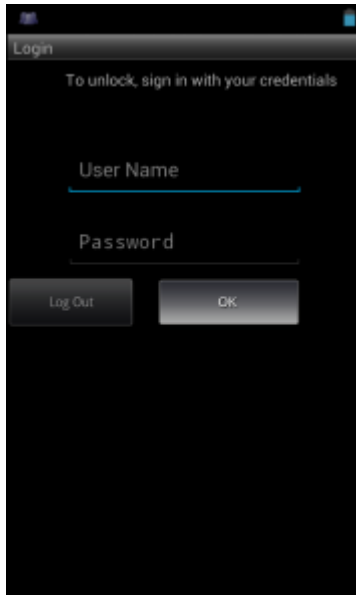
Figure 39: Multiple User Log In Screen

- 2 In the **Password** text field, enter the password.
- 3 Touch **OK**. After a resume from suspend, the user must enter the password.

MultiUser Logout

Procedure:

- 1 Drag the Status Bar down from the top of the screen.
- 2 Touch **MultiUser is active**.
- 3 Touch **Logout**.
- 4 The **Login** screen appears.

Resetting the Device

There are two reset functions, soft reset and hard reset.

Performing a Soft Reset

Perform a soft reset if applications stop responding.

Procedure:

- 1 Press and hold the Power button until the menu appears.
- 2 Touch **Reset**.
- 3 The device reboots.

Performing a Hard Reset



Caution: Performing a hard reset with a SD card installed in the TC70 may cause damage or data corruption to the SD card.

Perform a hard reset if the TC70 stops responding.

Procedure:

- 1 Simultaneously press the Power, PTT and Volume Up buttons for at least four seconds.

Figure 40: Three Button Reset

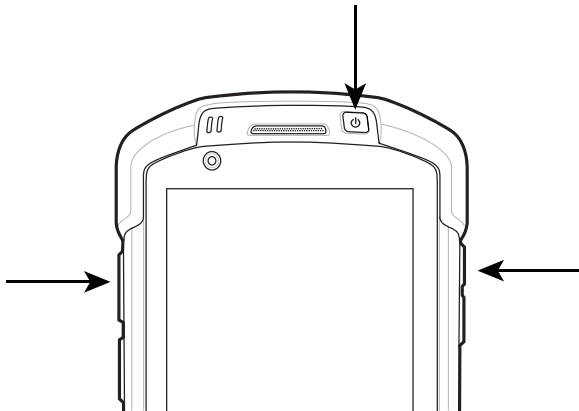



- 2 When the screen turns off, release the buttons.
- 3 The TC70 reboots.

Suspend Mode

The TC70 goes into suspend mode when the user presses the Power button or after a period of inactivity (set in the Display settings window).

To wake the TC70 from Suspend mode, press the Power button.

The Lock screen displays. Slide  to the right toward  to unlock the screen. If the Pattern screen unlock feature is enabled, the Pattern screen appears instead of the Lock screen. See [Un-Locking the Screen on page 51](#).



Note:

If the user enters the PIN, password or pattern incorrectly five times, they must wait 30 seconds before trying again.

If the user forgets the PIN, password or pattern contact the system administrator.

Figure 41: Lock Screen

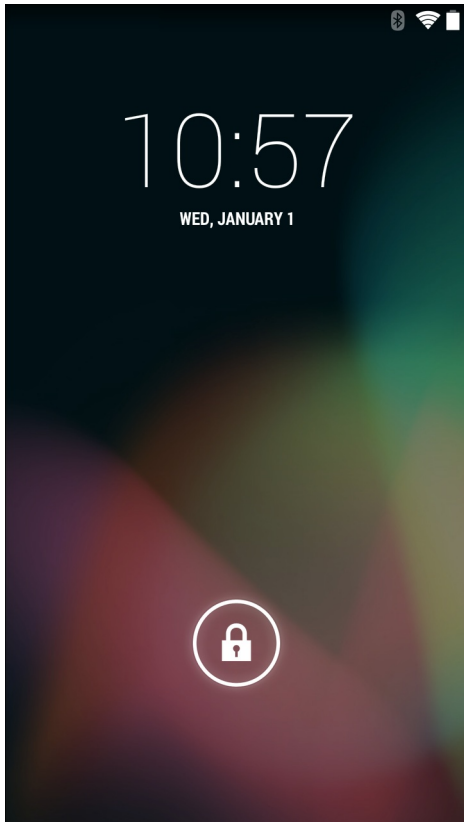

Chapter 3

Applications

This section describes the applications installed on the device.

File Browser

Use the **File Browser** application to view and manage files on the device.





To open **File Browser**, touch  > .

Figure 42: File Browser Screen



The address bar (1) indicates the current folder path. Touch the current folder path to manually enter a path and folder name.

Use  (2) to select multiple files/folder.

Use  (3) to view the internal storage root folder.

Use  (4) to view the microSD card root folder.

Use  (5) to view the previous folder or to exit the application.

Touch and hold an item to perform an operation on that item. Select one of the options from the **File Operations** menu:

- **Information** - View detailed information about the file or folder.
- **Move** - Move the file or folder to a new location.
- **Copy** - Copy the select file.
- **Delete** - Delete the selected file.
- **Rename** - Rename the select file.
- **Open as** - Open the selected file as a specific file type.
- **Share** - Share the file with other devices.

People

Use the **People** application to manage contacts.

From a Home or **Apps** screen, touch . **People** opens to the main list of contacts. View contacts in three ways at the top of the screen: Groups, All contacts, and Favorites. Touch the tabs to change how to view the contacts. Swipe up or down to scroll through the lists.



Adding People

Procedure:

- 1 In the **People** application, touch .
- 2 If there are more than one account with contacts, touch the one to use.
- 3 Type the contact's name and other information. Touch a field to start typing, and swipe down to view all categories.
- 4 To add more than one entry for a category – for example, to add a work address after typing a personal address – touch **Add new** for that field. To open a menu with preset labels, such as Home or Work for an email address, touch the label to the right of the item of contact information. Or, to create your own label, touch **Custom** in the menu.
- 5 Touch **Done**.

Editing People

Procedure:

- 1 In the **People** application, touch  tab.
- 2 Touch a person to edit.
- 3 Touch .
- 4 Touch **Edit**.
- 5 Edit the contact information.
- 6 Touch **Done**.

Deleting People

Procedure:

- 1 In the **People** application, touch  tab.
- 2 Touch a person to edit.
- 3 .
- 4 Touch **Delete**.

- 5 Touch **OK** to confirm.

Camera

This section provides information for taking photos and recording videos using the integrated digital cameras.



Note: If a microSD card is installed, The TC70 saves photos and videos on the microSD card. If a microSD card is not installed, the TC70 saves photos and videos on the internal storage.

Figure 43: Camera Photo Screen

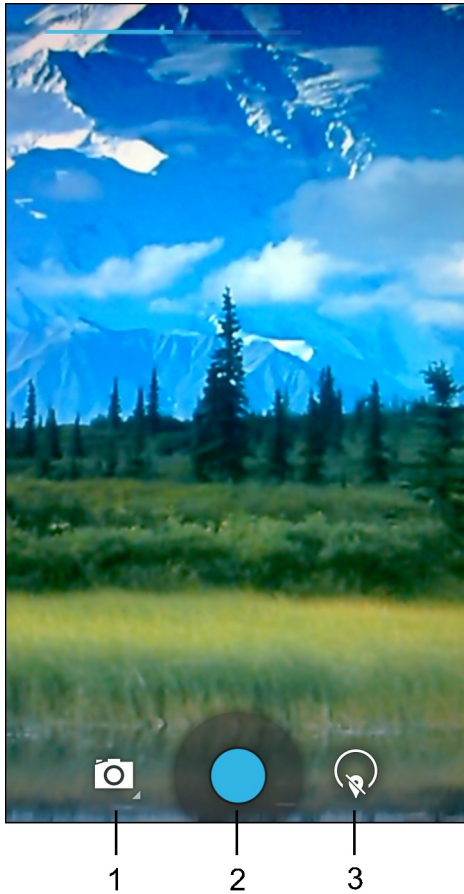

1	Camera Options — Touch to select Camera, Video or Panorama mode.
2	Shutter button - Touch to take a photo, a panoramic photo or to record a video.
3	Photo Settings – Touch to select camera settings.

Taking Photos



Note:

Camera settings are described in *Photo Settings on page 66*.

Procedure:



- 1 Touch .

- 2 Touch .

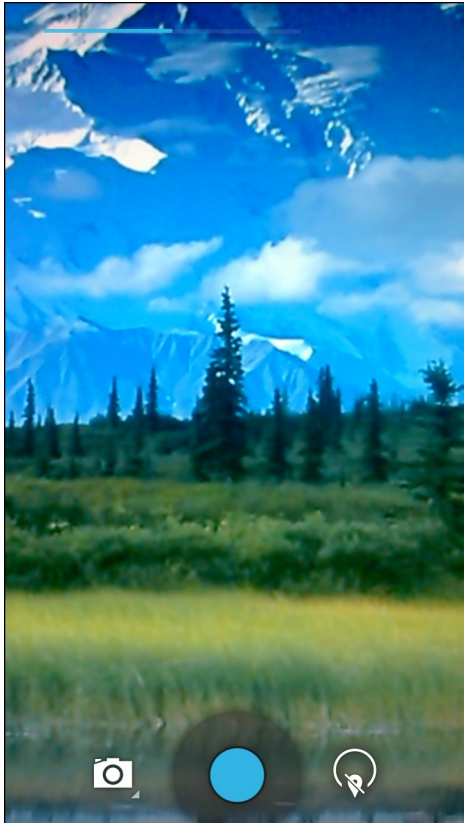
Figure 44: Camera Mode





- 3 If necessary, touch the camera options icon and touch .

- 4 To switch between the rear camera and front camera, touch  and then  or .

- 5 Frame the subject on the screen.

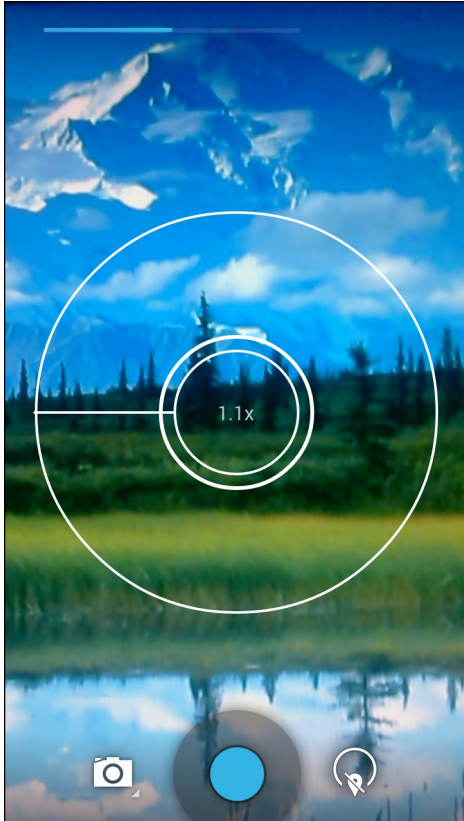
- 6 To zoom in or out, press two fingers on the display and pinch or expand fingers. The zoom controls appear on the screen.

Figure 45: Camera Zoom

- 7 Touch an area on the screen to focus. The focus circle appears on the screen. The two horizontal bars turn green when in focus.
- 8 Touch .

The camera takes a photo and a shutter sound plays.

Alternately, touch  and hold to focus first, before taking a photo; then release to take a focused photo.

The photo momentarily displays as a thumbnail in the upper right corner.

Taking a Panoramic Photo

Panorama mode lets the user create a single wide image by panning slowly across a scene.

Procedure:

- 1 Touch .
- 2 Touch .

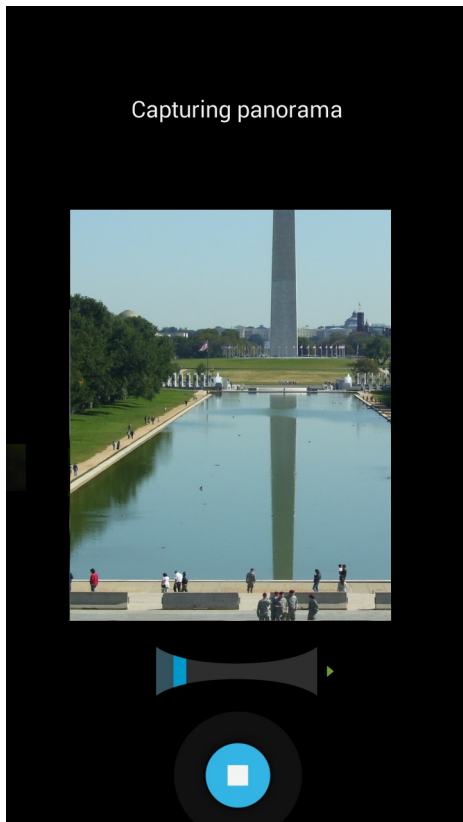
Figure 46: Panoramic Mode

3

Touch the options bar and touch .

4 Frame one side of the scene to capture.

5 Touch  and slowly start panning across the area to capture. A small white square appears inside the button indicating the capture is in progress.

If panning too quickly, the message **Too fast** appears.

6 Touch  to end the shot. The panorama appears immediately and a progress indicator displays while it saves the image.

Recording Videos

To record a video:

Procedure:

1 Touch .

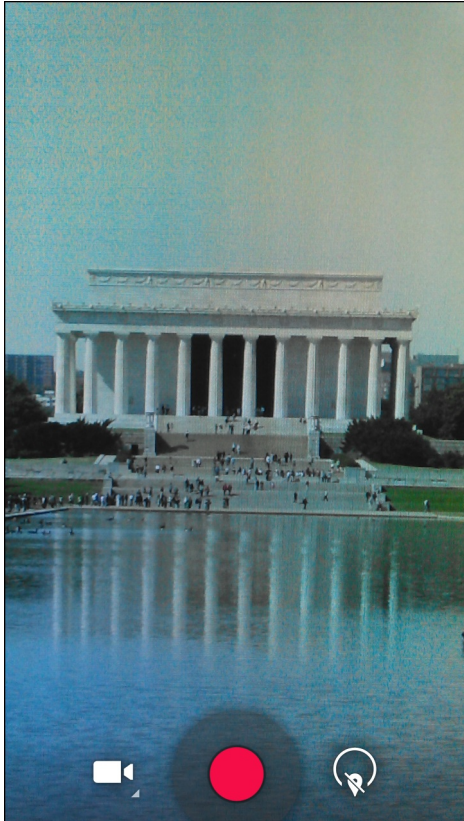

2 Touch .

Figure 47: Video Mode



3 Touch the options bar and touch .

4

To switch between the rear camera and front camera, touch  and then  or .

5 Point the camera and frame the scene.

6 To zoom in or out, press two fingers on the display and pinch or expand fingers. The zoom controls appear on the screen.

Figure 48: Camera Zoom

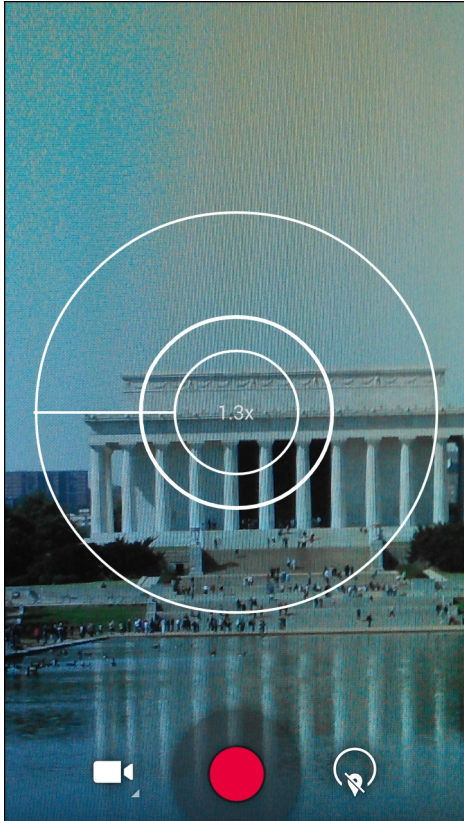

7 Touch  to start recording.

The device starts recording the video. The video time remaining appears in the top left of the screen.

8 Touch  to end recording.

The video momentarily displays as a thumbnail in the upper right corner.

Photo Settings

When in Photo mode, photo settings are displayed on screen. Touch  to display the photo settings options.

Rear Camera



Touch  to display the photo setting options.

Figure 49: Rear Photo Setting Options





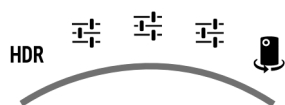







- **HDR** – Touch to enable High Dynamic Range (HDR) imaging. HDR adds more dynamic range to photographs (the ratio of light to dark). HDR uses three photos, taken at different exposures to create the photo (default - disabled).
- First :

- **Scene mode** - Touch to select a preset combination of camera settings designed for specific scenes. Options: **Auto** (default), **Night**, **Portrait**, **Landscape**, **Steady Photo** or **Sports**.
- **Picture size** - Touch to set the size (in pixels) of the photo. Options: **8M pixels** (default), **5M pixels**, **3M pixels**, **HD 1080p**, **2M pixels**, **HD 720p**, **1M pixels**, **WVGA**, **VGA** or **QVGA**.
- **Select Picture Format** - Touch to set the format of the photo. Options: **Jpeg** (default), **RAW** or **YUV420SP**.
- **Picture quality** - Touch to select picture quality setting. Options: **Jpeg 55%**, **Jpeg 65%**, **Jpeg 75%**, **Jpeg 85%**, **Jpeg 95%**, **Jpeg 100%**, **Super fine** (default), **Fine** or **Normal**.
- **ZSL** - Set the camera to immediately take a picture when the button is pressed (default – disabled)
- **Countdown timer** - Options: **Off** (default), **1 second**, **2 seconds**, **3 seconds**, **4 seconds**, **5 seconds**, **10 seconds**, **15 seconds**, **20 seconds**, **30 seconds** or **60 seconds**.
- **Beep during countdown** - Select to play a beep tone during countdown (default – enabled).

• Second :

- **Face detection** - Select to enable face detection (default – enabled).
- **Touch AF/AEC** - Select to enable auto focus (default – enabled).
- **Sharpness** - Touch to select a sharpness level. Options: **Level 0**, **Level 1**, **Level 2**, **Level 3** (default), **Level 4**, **Level 5** or **Level 6**.
- **Select Auto Exposure** - Touch to select auto exposure setting. Options: **Frame Average** (default), **Center Weighted** or **Spot Metering**.

• Third :

- **Anti Banding** - Options: **Off** (default), **50 Hz**, **60 Hz** or **Auto**.
- **Select ISO** - Set how sensitive the camera is to light. Options: **Auto** (default), **ISO Auto (HJR)**, **ISO100**, **ISO200**, **ISO400**, **ISO800** or **ISO1600**.
- **Exposure** - Touch to adjust the exposure settings. Options: **+2**, **+1**, **0** (default), **-1** or **-2**.
- **White balance** - Touch to select how Camera adjusts colors in different kinds of light, to achieve the most natural-looking colors.
 - +  **Incandescent** - Adjust the white balance for incandescent lighting.
 - +  **Fluorescent** - Adjust the white balance for florescent lighting.
 - +  **Auto** - Adjust the white balance automatically (default).
 - +  **Daylight** - Adjust the white balance for daylight.
 - +  **Cloudy** - Adjust the white balance for a cloudy environment.
- **Flash mode** - Touch to set whether Rear-facing Camera relies on its light meter to decide whether a flash is necessary, or to turn it on or off for all shots.
 - +  **Off** - Disable flash.
 - +  **Auto** - Camera adjusts flash automatically depending upon light meter (default).
 - +  **On** - Enable flash upon taking a photo.
 - +  **Torch** - Turn flash on continuously.
- **Focus Mode** - Touch to select the camera focus setting. Options: **Auto** (default), **Infinity**, **Macro** or **CAF** (Continuous Auto Focus).
- **AE-Bracket** - Touch to set Automatic Exposure Bracketing (default – disabled).







– Touch to switch to the front camera.

Front Camera

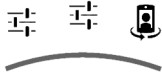

Touch to display the photo setting options.

Figure 50: Front Photo Setting Options

- First :
 - **Picture size** - Touch to set the size (in pixels) of the photo. Options: **HD 720p** (default), **1M pixels**, **WVGA**, **VGA** or **QVGA**.
 - **Select Picture Format** - Touch to set the format of the photo. Options: **Jpeg** (default), **RAW** or **YUV420SP**.
 - **Picture quality** - Touch to select picture quality setting. Options: **Jpeg 55%**, **Jpeg 65%**, **Jpeg 75%**, **Jpeg 85%**, **Jpeg 95%**, **Jpeg 100%**, **Super fine** (default), **Fine** or **Normal**.
 - **Countdown timer** - Options: **Off** (default), **1 second**, **2 seconds**, **3 seconds**, **4 seconds**, **5 seconds**, **10 seconds**, **15 seconds**, **20 seconds**, **30 seconds** or **60 seconds**.
 - **Beep during countdown** - Select to play a beep tone during countdown (default – enabled).
- Second :
 - **Face detection** - Select to enable face detection (default – enabled).
- 
 - Touch to switch to the rear camera.

Video Settings

When in Video mode, video settings are displayed on screen. Touch  to display the video settings options.

Rear Camera









Touch  to display the photo setting options.

Figure 51: Rear Video Setting Options

- First :
 - **Time lapse** - Touch to select a time interval to set the frame rate for time lapse photography. Options: **Off** (default), Slide switch to **ON** and then set time interval.
 - **Video quality** - Touch to select video quality:
 - + **HD 1080p** - High definition 1080p (default).
 - + **HD 720p** - High definition 720p.
 - + **SD 480p** - Standard definition 480p.
 - **Video duration** - Options: **30 seconds (MMS)** or **30 minutes** (default).
- Second :
 - **White balance** - Touch to select how Camera adjusts colors in different kinds of light, to achieve the most natural-looking colors.
 - +  **Incandescent** - Adjust the white balance for incandescent lighting.

- +  **Fluorescent** - Adjust the white balance for florescent lighting.
- +  **Auto** - Adjust the white balance automatically (default).
- +  **Daylight** - Adjust the white balance for daylight.
- +  **Cloudy** - Adjust the white balance for a cloudy environment.
- **Video High FrameRate** - Options: **Off** (default), **60** or **90**.
- **Flash mode** - Select to turn on flash (default – disabled).

-  – Touch to switch to the front camera.

Front Camera



Touch  to display the photo setting options.

Figure 52: Front Video Setting Options

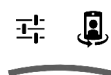

- 
 - **Time lapse** - Touch to select a time interval to set the frame rate for time lapse photography. Options: **Off** (default), Slide switch to **ON** and then set time interval.
 - **Video quality** - Touch to select video quality:
 - + **HD 720p** - High definition 720p (default).
 - + **SD 480p** - Standard definition 480p.
 - **Video duration** - Options: **30 seconds (MMS)** or **30 minutes** (default).
-  – Touch to switch to the rear camera.

Gallery





Note:

The device supports the following image formats: jpeg, gif, png and bmp.

The device supports the following video formats: H.263, H.264 and MPEG4 Simple Profile.

Use **Gallery** to:

- view photos
- play videos
- perform basic editing of photos
- set photos as wallpaper
- set photos as a contact photo
- share photos and videos.

To open the Gallery application, touch  >  or in the camera application touch the thumbnail image at the top right.

Gallery presents all photos and videos stored on the microSD card and internal memory.

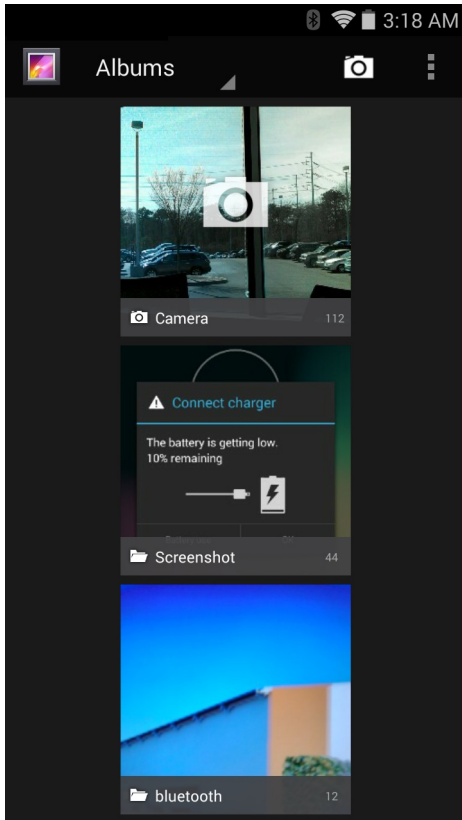
Figure 53: Gallery — Albums

- Touch an album to open it and view its contents. The photos and videos in the album are displayed in chronological order.
- Touch a photo or video in an album to view it.
- Touch  to return to the main **Gallery** screen.

Working with Albums

Albums are groups of images and videos in folders. Touch an album to open it. The photos and videos are listed in a chronologically ordered grid. The name of the album displays at the top of the screen.



Figure 54: Photos Inside an Album



Swipe left or right to scroll images across the screen.

Share an Album

Procedure:

- 1 Touch .
- 2 Touch .
- 3 Touch and hold an album until it highlights.
- 4 Touch other albums as required.
- 5 Touch . The Share menu opens. Touch the application to use to share the selected albums.
- 6 Follow the instructions within the selected application.

Get Album Information

Procedure:



- 1 Touch .
- 2 Touch .
- 3 Touch and hold an album until it highlights.

- 4 Touch .
- 5 Touch **Details**.

Deleting an Album

To delete an album and its contents:

Procedure:

- 1 Touch .
- 2 Touch .
- 3 Touch and hold an album until it highlights.
- 4 Check other albums to delete. Ensure that other albums are selected.
- 5 Touch  > **Delete**.
- 6 In the **Delete selected item?** menu, touch **OK** to delete the album.

Working with Photos

Use **Gallery** to view photos on the microSD card and edit and share photos.

Viewing and Browsing Photos

To view a photo:

Procedure:



- 1 Touch .
- 2 Touch .
- 3 Touch an album to open it.
- 4 Touch a photo.

Figure 55: Photo Example



- 5 Swipe left or right to view the next or previous photo in the album.
- 6 Turn the device to view the photo in upright (portrait) or sideways (landscape) orientation. The photo is displayed (but not saved) in the new orientation.
- 7 Touch the photo to view the controls.
- 8 Double-tap the screen to zoom in or pinch two fingers together or spread them apart to zoom in or out.
- 9 Drag the photo to view parts that are not in view.

Cropping a Photo

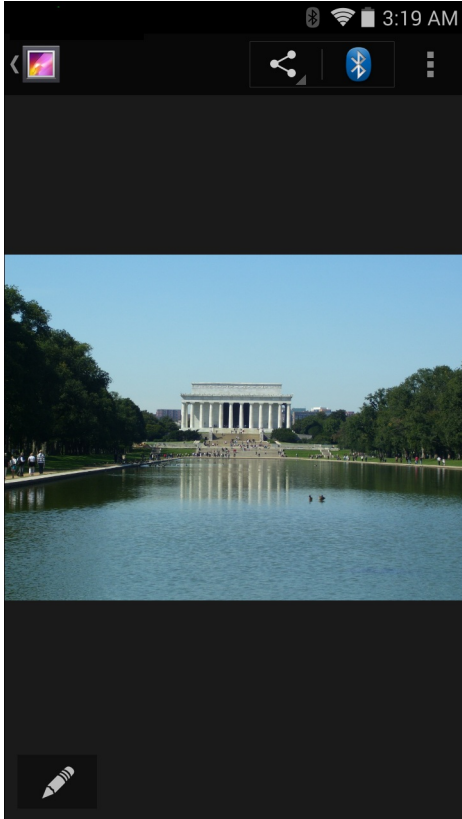
Procedure:





- 1 In **Gallery**, touch a photo to view the controls.
- 2 Touch .
- 3 Touch **Crop**. The cropping tool appears.
- 4 Use the cropping tool to select the portion of the photo to crop.
 - Drag from the inside of the cropping tool to move it.
 - Drag an edge of the cropping tool to resize it to any proportion.
 - Drag a corner of the cropping tool to resize it with fixed proportions.

Figure 56: Cropping Tool

- 5 Touch **Save** to save a copy of the cropped photo. The original version is retained.

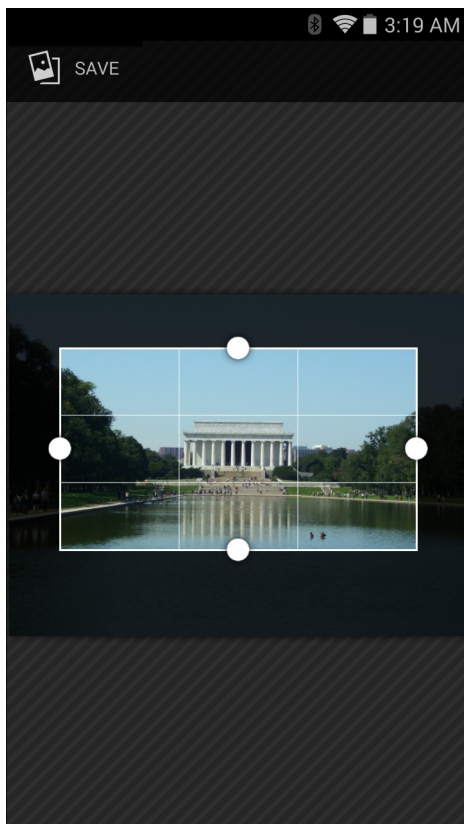
Setting a Photo as a Contact Icon

Procedure:

- 1 Touch .
- 2 Touch .
- 3 Touch an album to open it.
- 4 Touch the photo to open it.
- 5 Touch .
- 6 Touch **Set picture as**.
- 7 Touch **Contact photo**.
- 8 In the **People** application, touch a contact.
- 9 Touch the blue box and crop the photo accordingly.
- 10 Touch **OK**.

Share a Photo

Procedure:

- 1 Touch .
- 2 Touch .

3 Touch an album to open it.

4 Touch a photo to open it.

5



Touch

6 Touch the application to use to share the selected photo. The application selected opens with the photo attached to a new message.

Deleting a Photo

Procedure:

1

Touch .

2

Touch .

3 Touch an album to open it.

4 Touch a photo to open it.

5

Touch .

6 Touch **Delete**.

7 Touch **OK** to delete the photo.

Working with Videos

Use **Gallery** to view videos and share videos.

Watching Videos

Procedure:

1

Touch .



2

Touch .

3 Touch an album to open it.

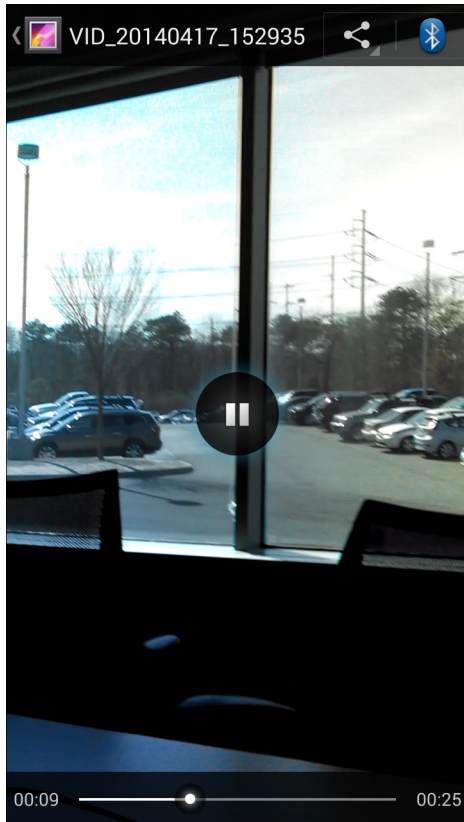



4 Touch a video.

Figure 57: Video Example

- 5  Touch . The video begins to play.
- 6 Touch the screen to view the playback controls.

Sharing a Video





Procedure:

- 1 Touch .
- 2 Touch .
- 3 Touch an album to open it.
- 4 Touch a video to open it.
- 5  Touch . The Share menu appears.
- 6 Touch the application to use to share the selected video. The application selected opens with the video attached to a new message.

Deleting a Video

Procedure:

- 1 Touch .

- 2  Touch .
- 3 Touch an album to open it.
- 4 Touch a video to open it.
- 5  Touch .
- 6 Touch **Delete**.
- 7 Touch **OK**.

DataWedge Demonstration

Use **DataWedge Demonstration** to demonstrate data capture functionality.

Figure 58: DataWedge Demonstration Window

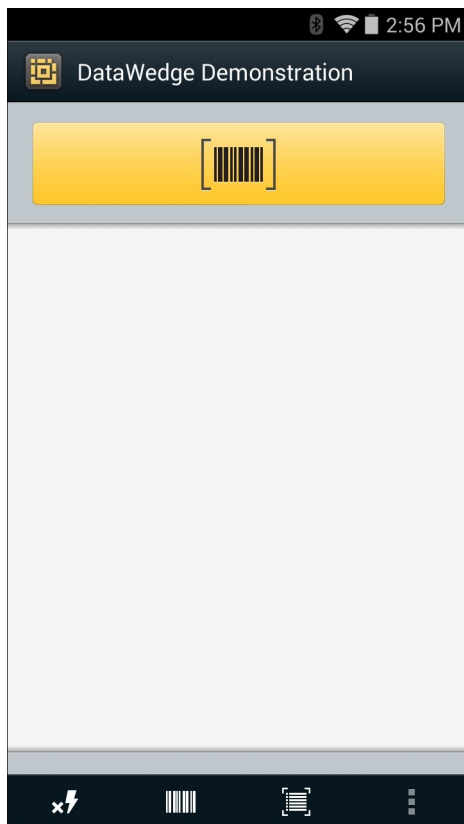

Table 9: DataWedge Demonstration Icons





Icon	Description
	Not applicable.
	Indicates that the data capture function is through the imager.
	Toggles between normal scan mode and picklist mode when using the imager to capture bar code data.

Table continued...

Icon	Description
	Opens a menu to view the application information or to set the application DataWedge profile.

**Note:**

See the *TC70 Integrator Guide* for information on DataWedge configuration.

Either press the programmable button or touch the yellow scan button to enable data capture. The captured data appears in the text field below the yellow button.

Sound Recorder

Use **Sound Recorder** to record audio messages.

Recordings are saved on the microSD card (if installed) or the Internal Storage and available in the Music application playlist titled "My Recordings."

Figure 59: Sound Recorder Application

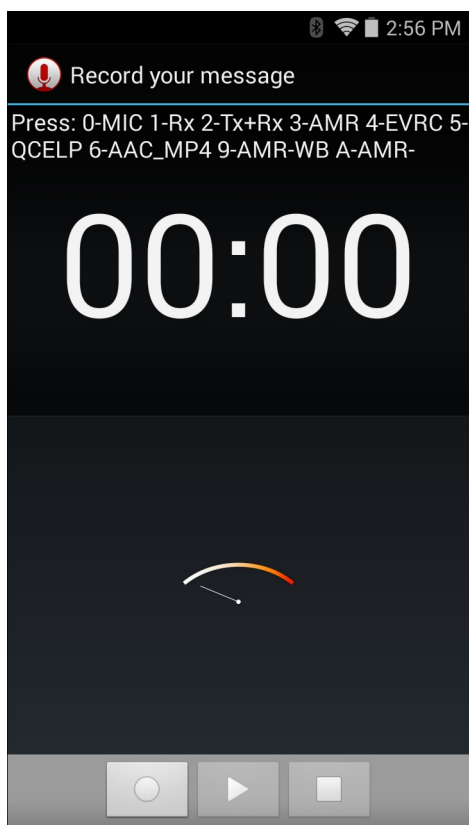

PTT Express Voice Client

**Note:**

PTT Express Voice Client creates Push-To-Talk (PTT) communication capability between disparate enterprise devices. Leveraging existing Wireless Local Area Network (WLAN) infrastructure, PTT Express delivers simple PTT communication without the need of a voice communication server.

- **Group Call:** Press and hold the PTT (Talk) button to start communicating with other voice client users.

PTT Audible Indicators

The following tones provide helpful cues when using the voice client.

- **Talk Tone:** Double chirp. Plays when the Talk button is depressed. This is a prompt for the user to start talking.
- **Access Tone:** Single beep. Plays when another user just finished a broadcast or response. The user is now able to initiate a Group Broadcast or Private Response.
- **Busy Tone:** Continuous tone. Plays when the Talk button is depressed and another user is already communicating on the same talkgroup. Plays after the maximum allowed talk time is reached (60 seconds).
- **Network Tone:**
 - Three increasing pitch beeps. Plays when PTT Express has acquired the WLAN connection and the service is enabled.
 - Three decreasing pitch beeps. Plays when PTT Express has lost the WLAN connection or the service is disabled.

Figure 60: PTT Express Default User Interface

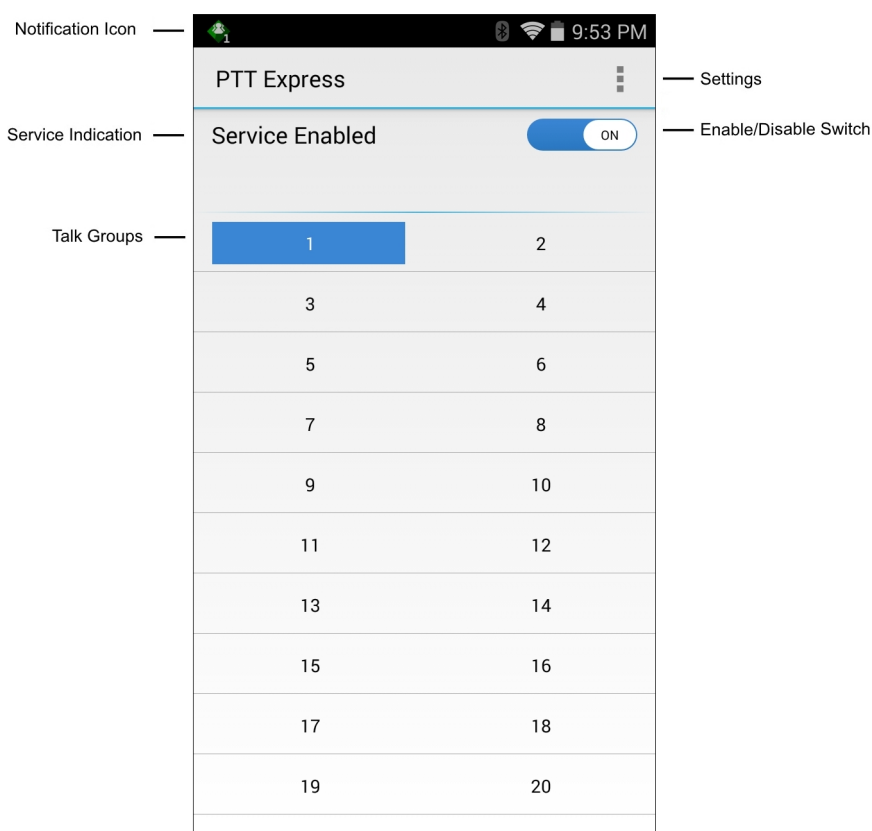

Table 10: PTT Express Default User Interface Descriptions

Item	Description
Notification Icon	Indicates the current state of the PTT Express client.
Service Indication	Indicates the status of the PTT Express client. Options: Service Enabled , Service Disabled or Service Unavailable .
Talk Groups	Lists all 32 Talk Groups available for PTT communication.







Table continued...

Item	Description
Settings	Opens the PTT Express Settings screen.
Enable/Disable Switch	Turns the PTT service on and off.

Notification Icons



Indicates the current state of the PTT Express Voice client.

Table 11: PTT Express Default User Interface Descriptions

Status Icon	Description
	Indicates that PTT Express Voice client is disabled.
	Indicates that PTT Express Voice client is enabled but not connected to a WLAN.
	Indicates that PTT Express Voice client is enabled, connected to a WLAN and listening on the Talk Group indicated by the number next to the icon.
	Indicates that PTT Express Voice client is enabled, connected to a WLAN and communicating on the Talk Group indicated by the number next to the icon.
	Indicates that PTT Express Voice client is enabled, connected to a WLAN and in a private response.
	Indicates that PTT Express Voice client is enabled and muted.
	Indicates that the PTT Express Voice client is enabled but it is not able to communicate due to a VoIP telephony call is in progress.

Enabling PTT Communication

Procedure:

- 1 Touch .
- 2 Touch .
- 3 Slide the **Enable/Disable Switch** to the **ON** position. The button changes to an **ON** button.

Selecting a Talk Group

One of 32 Talk Groups can be selected by PTT Express users. However, only one talk group may be enabled at a time on the device. Touch one of the 32 Talk Groups. The selected Talk Group is highlighted.

PTT Communication



Note: This section describes the default PTT Express client configuration. See the *PTT Express V1.2 User Guide* for detailed information on using the client.

PTT communication may be established as a Group Call. When PTT Express is enabled, the PTT button on the left side of the device is assigned for PTT communication. When the Wired Headset is used, Group Calls can also be initiated using the headset Talk button.

Figure 61: PTT Buttons

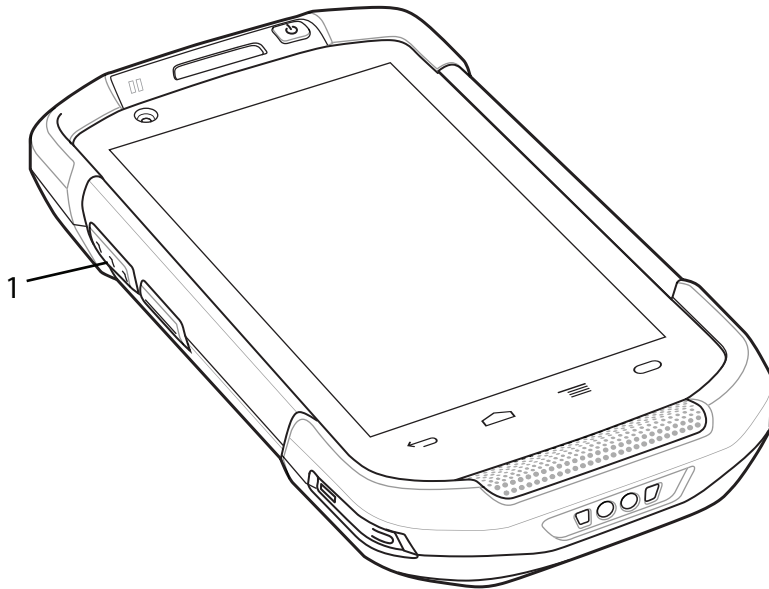

1	PTT Button
---	------------

Figure 62: Wired Headset

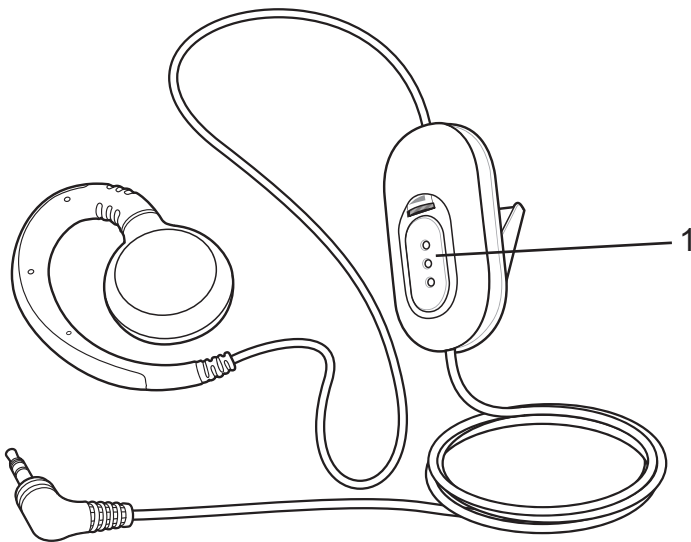

1	Talk Button
---	-------------

Creating a Group Call

Procedure:

- 1 Press and hold the PTT button (or the Talk button on the headset) and listen for the talk tone to play. If a busy tone is heard, release the button and wait a moment before making another attempt. Ensure that PTT Express and the WLAN are enabled.

- 2 Start talking after the talk tone is heard.



Note: If the user holds the button for more than 60 seconds (default), the call is dropped allowing others to make Group calls. The user should release the button when finished talking to allow others to make calls.

- 3 Release the button when finished talking.

Disabling PTT Express Voice Client Communication

Procedure:

- 1 Touch
- 2 Touch
- 3 Slide the **Enable/Diable Switch** to the **OFF** position. The button changes to **OFF**.
- 4 Touch

MLog Manager

Use **MLog Manager** to capture log files for diagnostics. See the *TC70 Integrator Guide* for detailed information on configuring the application.

Figure 63: MLog Manager

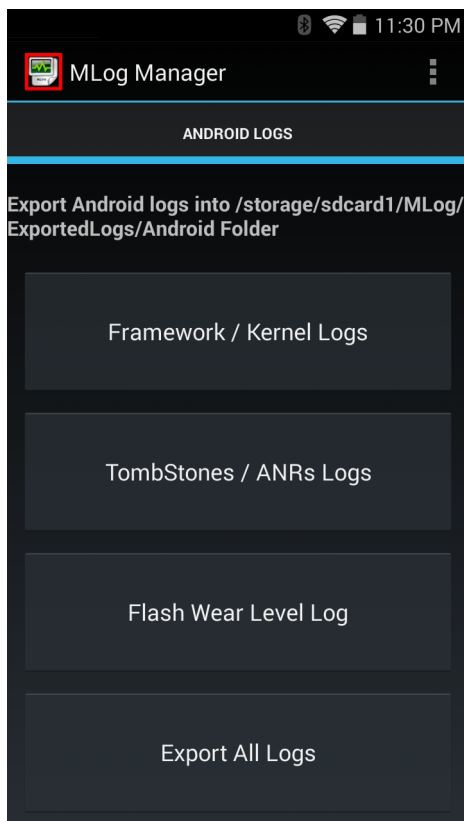

SimulScan Demo

The SimulScan application is an out of the box demonstration application included on the device that support SimulScan. The application enables pre-sales personnel to showcase the various features of SimulScan to customers by employing use-cases in the two most popular verticals, Postal/Transportation and Logistics and Manufacturing. The Transportation and Logistics example showcases the OCR and OMR features. The Manufacturing example showcases the MultiCode 20 feature. SimulScan also allows customers to create templates using the Template Builder and then testing on the device.

Figure 64: SimulScan Demo Home Screen



Exporting Sample Forms

In order to perform the Postal, Transportation & Logistics or Manufacturing demonstrations, print the example forms stored on the device.

Procedure:

- 1 Launch **SimulScan Demo** application.
- 2 On the **SimulScan Demo** home screen, touch **HOW TO USE THIS DEMO**.
- 3 Scroll down and touch **Export sample forms** button. The device copies the forms to the `\simulscan` `\samples` folder in Internal Storage.
- 4 Connect the device to a computer using the USB Charging cable.
- 5 Copy the files from the `\simulscan\samples` folder in Internal Storage to the computer.
- 6 Print the forms.

Postal, Transportation and Logistics Example

The Postal, Transportation and Logistics example uses the following form:

Figure 65: Postal, Transportation and Logistics Form

1. Payer account number and insurance details		2. Non-Document Shipments Only (Customs Requirements)		5. Shipper's agreement	
Charge to <input checked="" type="checkbox"/> Shipper <input type="checkbox"/> Receiver <input type="checkbox"/> 3rd party <small>Not all payment options are available in all countries.</small> Payer Account No.: 001-12349876		Attach the original and four copies of a Proforma or Commercial Invoice Shipper's VAT/GST number: 564451112 Receiver's VAT/GST or Shipper's EIN/SSN: 1111577738 Harmonized Commodity Code if applicable:		(Signature required) <small>Unless otherwise agreed in writing, we agree to the Terms and Conditions of Carriage between the (1) sender and (2) carrier and (3) receiver and (4) addressee, where applicable, the Convention only and/or excluded liability for loss, damage or delay and (5) the agreement does not constitute each or all of the above.</small>  Signature _____ Date: 10 / 10 / 13	
Shipment Insurance (see reverse) <input checked="" type="checkbox"/> Via Insurance value (in local currency): 1400		Destination duties/taxes if not paid by receiver (see reverse): <input type="checkbox"/> Receiver <input type="checkbox"/> Shipper <input type="checkbox"/> Other _____ <small>Specify approved account number</small>			
3. From (Shipper)		4. To (Receiver)			
Shipper's account number: 155-22263 Company name: Pure Theory Ltd Address: 1638 Lansdown Drive, Fitzrovia, London, England, WC2 1AB Contact name: Scott Andrews Phone, Fax or E-mail (required): 0207 553633		Company name: TFW Solutions Delivery address: <small>We cannot deliver to a PO Box</small> Solvalla, Travbaneplan 12A 64 Bromma Postcode/Zip Code (required): 266 32 Country: Sweden Contact person: Aidan Peterson Phone, Fax or E-mail (required): +46 8 123 89 67			

Procedure:

- 1 Place the form on a flat surface.
- 2 On the device, launch **SimulScan Demo** application.
- 3 Touch the **Menu** icon in the top right corner of the screen.
- 4 Touch **Postal, Transportation & Logistics**.
- 5 Touch **Start SimulScan**.
- 6 Use the image control at the bottom of the screen to control the flash, audio and zoom level.

Figure 66: Image Controls



- 7 Position the camera over the form. Ensure that the complete border of the form is visible on the screen.
- 8 Hold the device steady.
- 9 Once the device detects the form **Tap Screen to Scan** appears on the screen.

10 Tap the screen to start the data capture. When completed, the device beeps and the data from the form displays.

Figure 67: Postal Data Screen

Field	Parsed Data
Barcode	123456-789A
Charge To	<input checked="" type="checkbox"/>
Account Number	155-22263
Shipper Name	▲ Check Result Pure Theory Ltd
Shipper Address	▲ Check Result 1631 LaDWS@Bwn Drive Fitzrovia, London

Buttons: Rescan, Accept

11 Touch the text boxes to correct any errors. Note: if there are too many errors, touch **Rescan** to perform the capture again.

12 Touch **Accept** to confirm the data is correct. The **Results summary** screen appears.

13 Touch **OK**.

Manufacturing Example

The Postal, Transportation and Logistics example uses the following form:

Figure 68: Manufacturing Form

reader <5 kgs MV unit

PART NUMBER (P) 5290261-69

SUPPLIER (S) 4305156059

QUANTITY (Q) 000128

PKG ID/SERIAL NUMBER (IS) X1 000114

MADE IN MEXICO

MANUFACTURING LTD

Procedure:

- 1 Copy the sample form from the device to a computer. See
- 2 Print this form.
- 3 Place the form on a flat surface.

- 4 On the device, launch **SimulScan Demo** application.
- 5 Touch the **Menu** icon in the top right corner of the screen.
- 6 Touch **Manufacturing**.
- 7 Touch **Start SimulScan**.
- 8 Point the top of the device at the document and center the target on the document.
- 9 Hold the device steady.
- 10 The device starts the data capture. When completed, the device beeps and the data from the document displays.

Figure 69: Manufacturing Data

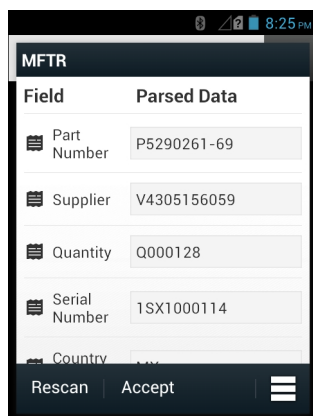

- 11 Touch the text boxes to correct any errors. If there are too many errors, touch **Rescan** to perform the capture again.
- 12 Touch **Accept** to confirm the data is correct. The **Results summary** screen appears.
- 13 Touch **OK**.

Settings

To set the settings for the **SimulScan Demo** application touch **Menu** icon > **Settings**.

Figure 70: Settings Screen

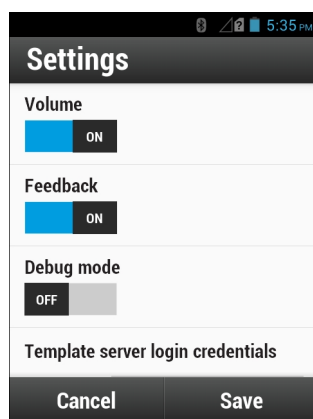

- **Volume** - Toggle switch to turn audible notification on and off.
- **Haptic** - Toggle switch to turn vibration notification on and off.
- **Debug mode** - Toggle switch to enable or disable debug mode.
- **Template server login credentials** - enter credentials for accessing the template server.

Demo Customization

Before creating a customized demo, first:

- Create a template using the Template Builder tool.
- Copy a company logo and image to the device storage location.

Procedure:

- 1 Touch **Menu** icon.
- 2 Touch **Custom Demo Setup**.

Figure 71: Custom Demo Setup Screen

- 3 In the **Name** text box, enter a name for the custom demo. This name appears in the drop-down menu..
- 4 In the **Custom Demo Setup** text box, enter a title for the demo. This appears in the demo screen title box.
- 5 Touch the **Image** field to select an image from the SD card.
- 6 Touch the **Logo** field to select the logo image from the SD card.
- 7 In the **Introduction** text box, enter text that will appear on the demo screen.
- 8 In the **Header color** text box, enter the hex color value for the header.
- 9 In the **Icon color** text box, enter the hex color value for Menu icon and button text.
- 10 In the **Key Features** text box, enter text that will appear under the Key Feature heading. This text appears in bullet format.
- 11 Touch one of the **SimulScan Document Capture Template** fields to select a template
 - a **Browse external storage** - select a template loaded on the device.
 - b **Default templates** - select one of the default templates.
 - c **Select from server** - . select a template from the SimulScan server.
- 12 Touch **Done**. The customized example appears on the screen.
- 13 Touch **Start SimulScan** to begin the demonstration.

RxLogger

RxLogger is a comprehensive diagnostic tool that provides application and system metrics. It allows for custom plugins to be created and work seamlessly with this tool. RxLogger is used to diagnose device and application issues. Its information tracking includes the following: CPU load, memory load, memory snapshots, battery consumption, power

states, wireless logging, cellular logging, TCP dumps, Bluetooth logging, GPS logging, logcat, FTP push/pull, ANR dumps, etc. All logs and files generated are saved onto flash storage on the device (internal or external).

Figure 72: RxLogger

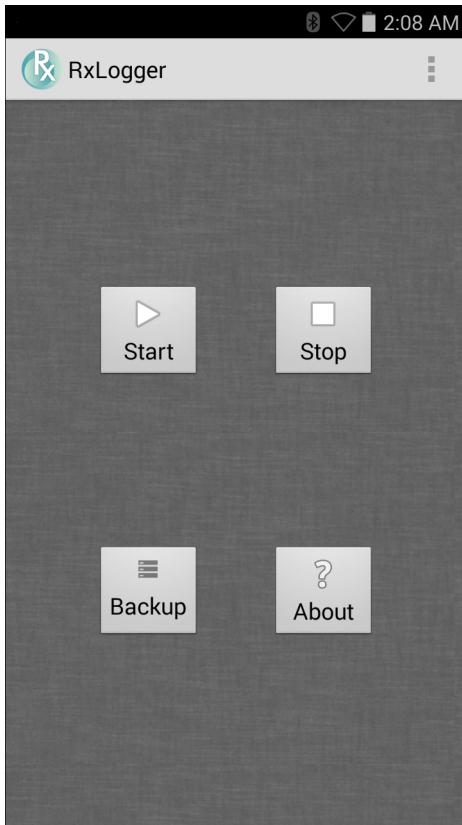

Elemesz



Note:

Elemesz collects specific device information in the background and sends this information to us to help improve product functionality. This feature can be disabled. See [Disabling Elemesz Data Collection on page 89](#).

Ensure that the date, time and time zone are set correctly prior to using Elemesz.

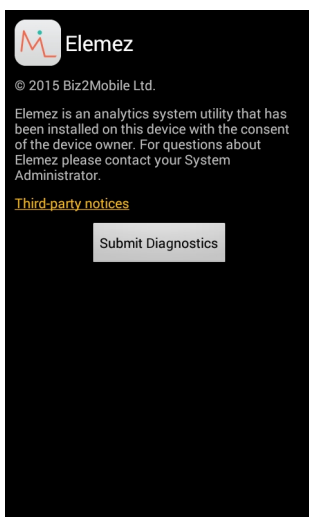

Use **Elemesz** to provide diagnostics information to Zebra. Touch **Submit Diagnostics** button to send the data.

Figure 73: Elemez Application

Disabling Elemez Data Collection

The user can disable the **Elemez** application from collection specific data in the background and sending it to Zebra Technologies.



Procedure:

- 1 From the Home screen, touch .
- 2 Touch **Manage Apps**.
- 3 Swipe left or right until the **ALL** tab displays.
- 4 Scroll through the list and touch **Elemez**.
- 5 In the **App info** screen, touch **Uninstall updates**.
- 6 In the **Uninstall updates** dialog box, touch **OK**.
- 7 Touch **OK**.
- 8 After uninstall is complete, touch **OK**.
- 9 In the **All** tab, scroll through the list and touch **Elemez**.
- 10 Touch **Disable**.
- 11 In the **Disable built-in app?** dialog box, touch **OK**.
- 12 Touch .

Enabling Elemez Data Collection

The user can re-enable the **Elemez** application for collection specific data in the background and sending it to Zebra Technologies.

Procedure:

- 1 From the Home screen, touch .
- 2 Touch **Manage Apps**.
- 3 Swipe left or right until the **ALL** tab displays.
- 4 Scroll through the list and touch **Elemez**.
- 5 In the **App info** screen, touch **Enable**.
- 6 Touch .
- 7 Touch .

8 Touch  or .

9 Touch **Enable Elemez**.

Chapter 4

Data Capture

The TC70 offers data capture using the integrated imager, camera or the RS507 Hands-free imager.



Note:

By default, the good decode beep is set to system volume (Music and Media). The good decode beep can be set to another sound (Notifications or Alarms) and the volume can be independently controlled. See the *DataWedge* section in the *TC70 Integrator Guide* for more information.

DataWedge is installed and enabled on the TC70 by default.

Imaging

The TC70 with an integrated imager has the following features:

- Omnidirectional reading of a variety of bar code symbologies, including the most popular linear, postal, PDF417, and 2D matrix code types.
- The ability to capture and download images to a host for a variety of imaging applications.
- Advanced intuitive laser aiming cross-hair and dot aiming for easy point-and-shoot operation.

The imager uses imaging technology to take a picture of a bar code, stores the resulting image in its memory, and executes state-of-the-art software decoding algorithms to extract the bar code data from the image.

Operational Modes

The TC70 with an integrated imager supports two modes of operation, listed below. Activate each mode by pressing the Scan button.

- **Decode Mode:** In this mode, the TC70 attempts to locate and decode enabled bar codes within its field of view. The imager remains in this mode as long as the user holds the scan button, or until it decodes a bar code.



Note: To enable Pick List Mode, configure in DataWedge or set in an application using a API command.

- **Pick List Mode:** This mode allows the user to selectively decode a bar code when more than one bar code is in the TC70 's field of view. To accomplish this, move the aiming crosshair or dot over the required bar code to decode only this bar code. This feature is ideal for pick lists containing multiple bar codes and manufacturing or transport labels containing more than one bar code type (either 1D or 2D).

RS507 Hands-Free Imager

The RS507 Hands-free Imager is a wearable bar code scan solution for both 1D and 2D bar code symbologies. The scanner supports Bluetooth Human Interface Device (HID) connection to the device.

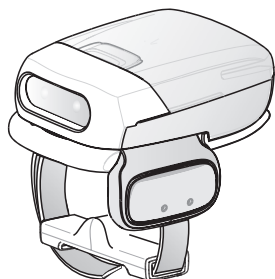
Figure 74: RS507 Hands-Free Imager

See to the *RS507 Hands-free Imager Product Reference Guide* for more information.

Scanning Considerations

Typically, scanning is a simple matter of aim, scan, and decode and a few quick trial efforts master it. However, consider the following to optimize scanning performance:

- *Range:* Any scanning device decodes well over a particular working range — minimum and maximum distances from the bar code. This range varies according to bar code density and scanning device optics. Scanning within range brings quick and constant decodes; scanning too close or too far away prevents decodes. Move the scanner closer and further away to find the right working range for the bar codes being scanned.
- *Angle:* Scanning angle is important for promoting quick decodes. When laser beams reflect directly back into the scanner from the bar code, this specular reflection can “blind” the scanner. To avoid this, scan the bar code so that the beam does not bounce directly back. But don’t scan at too sharp an angle; the scanner needs to collect scattered reflections from the scan to make a successful decode. Practice quickly shows what tolerances to work within.
- Hold the TC70 farther away for larger symbols
- Move the TC70 closer for symbols with bars that are close together.



Note: Scanning procedures depend on the application and TC70 configuration. An application may use different scanning procedures from the one listed above.

Imager Scanning

To read a bar code, a scan-enabled application is required. The TC70 contains the DataWedge application that allows the user to enable the imager, decode the bar code data and display the bar code content.

Procedure:

- 1 Ensure that an application is open on the TC70 and a text field is in focus (text cursor in text field).
- 2 Point the exit window on the top of the TC70 at a bar code.

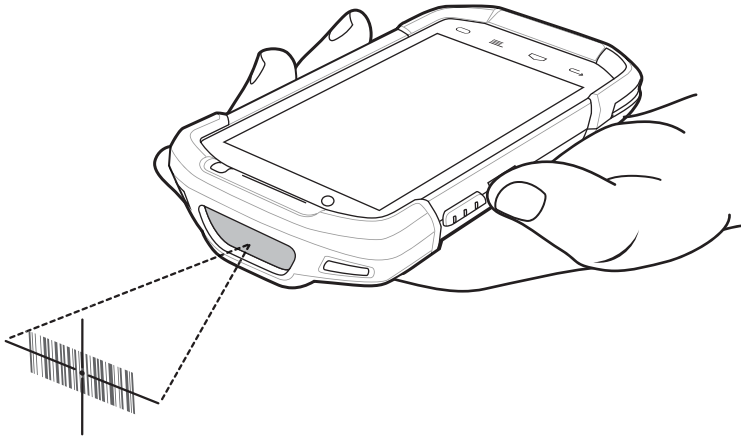
Figure 75: Imager Scanning

- 3 Press and hold the scan button.

The red laser aiming pattern turns on to assist in aiming.

- 4  **Note:** When the TC70 is in Picklist mode, the imager does not decode the bar code until the crosshair or aiming dot touches the bar code.

Ensure the bar code is within the area formed by the crosshairs in the aiming pattern. The aiming dot is used for increased visibility in bright lighting conditions.

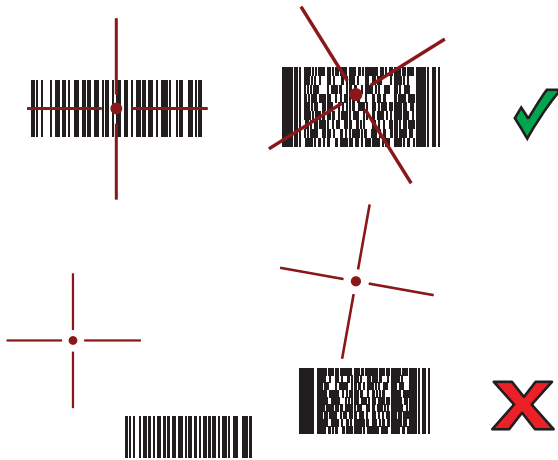
Figure 76: Aiming Pattern**Figure 77: Pick List Mode with Multiple Bar Codes in Aiming Pattern**

- 5 The Data Capture LED lights green and a beep sounds, by default, to indicate the bar code was decoded successfully.
- 6 Release the scan button.



Note: Imager decoding usually occurs instantaneously. The TC70 repeats the steps required to take a digital picture (image) of a poor or difficult bar code as long as the scan button remains pressed.

- 7 The bar code content data displays in the text field.

Bar Code Capture with RS507 Hands-Free Imager

Prerequisites: Pair the RS507 with the . See for more information.

Procedure:

- 1 Ensure that an application is open on the device and a text field is in focus (text cursor in text field).
- 2 Point the RS507 at a bar code.

Figure 78: Bar Code Scanning with RS507

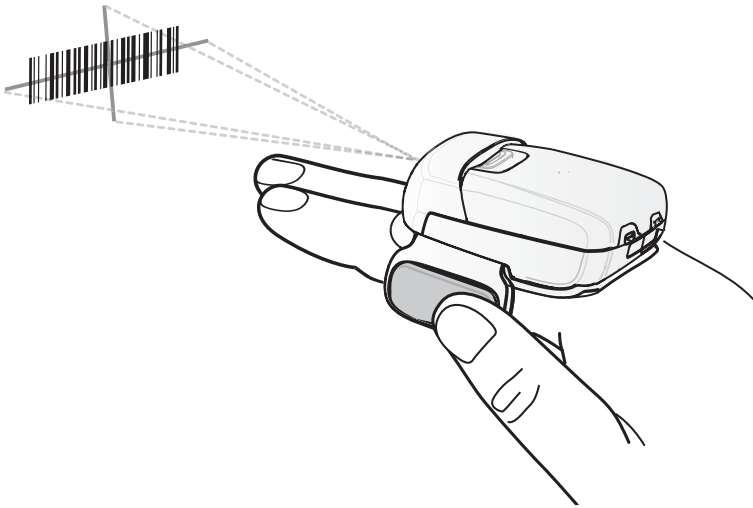

- 3 Press and hold the trigger.

The red laser aiming pattern turns on to assist in aiming. Ensure the bar code is within the area formed by the cross-hairs in the aiming pattern. The aiming dot is used for increased visibility in bright lighting conditions.

The RS507 LEDs light green, a beep sounds to indicate the bar code was decoded successfully. Note that when the RS507 is in Pick List Mode, the RS507 does not decode the bar code until the center of the crosshair touches the bar code.

Figure 79: Aiming Pattern

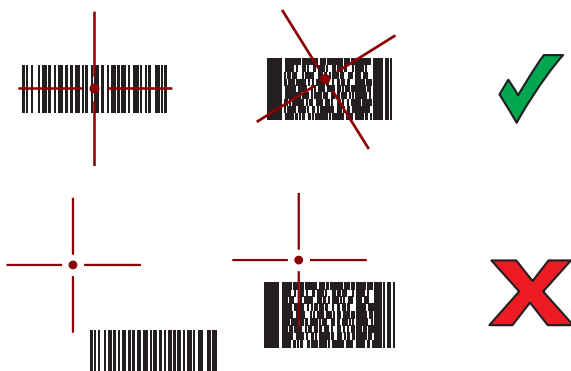

Figure 80: Pick List Mode with Multiple Bar Codes in Aiming Pattern

- 4 The captured data appears in the text field.

Pairing the RS507 Hands-Free Imager Using SSI

An RS507 Hands-free Imager can be used with the device to capture bar code data.

Procedure:



- 1 Ensure that the two devices are within 10 meters (32.8 feet) of one another.
- 2 Install the battery into the RS507.
- 3 On the TC70, touch .
- 4 Touch .

Figure 81: Bluetooth Pairing Utility

- 5 Using the RS507, scan the bar code on the screen.
The RS507 emits a high/low/high/low beeps. The Scan LED flashes green indicating that the RS507 is attempting to establish connection with the TC70. When connection is established, the Scan LED turns off and the RS507 emits one string of low/high beeps.

- 6 On the TC70, touch .

Pairing the RS507 Hands-Free Imager Bluetooth HID

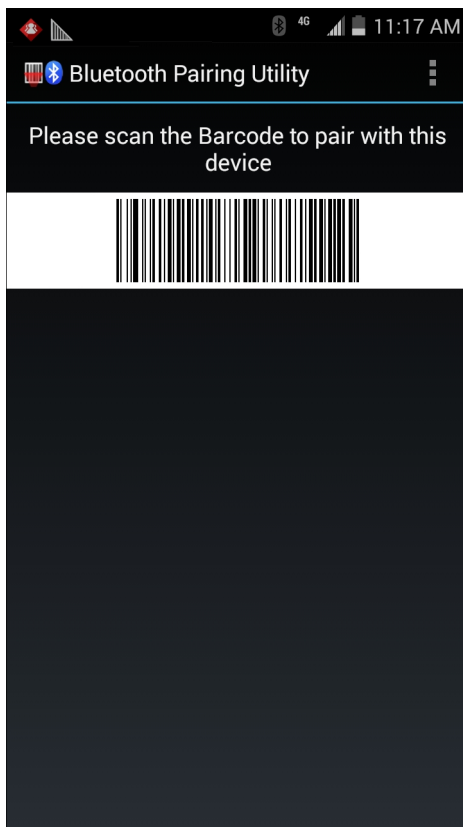

An RS507 Hands-free Imager can be used with the device to capture bar code data.

Procedure:

- 1 Ensure that Bluetooth is enabled on both devices.
- 2 Ensure that the Bluetooth device to discover is in discoverable mode.
- 3 Ensure that the two devices are within 10 meters (32.8 feet) of one another.
- 4 Place the RS507 in Human Interface Device (HID) mode. If the RS507 is already in HID mode, skip to step 5.
 - a Remove the battery from the RS507.
 - b Press and hold the Restore key.
 - c Install the battery onto the RS507.
 - d Keep holding the Restore key for about five seconds until a chirp is heard and the Scan LEDs flash green.
 - e Scan the bar code below to place the RS507 in HID mode.

Figure 82: RS507 Bluetooth HID Bar Code



- 5 Remove the battery from the RS507.
- 6 Re-install the battery into the RS507.
- 7 On the TC70, touch .
- 8 Touch .
- 9 Touch  **Bluetooth**.
- 10 Touch **SCAN FOR DEVICES**. The device begins searching for discoverable Bluetooth devices in the area and displays them under **AVAILABLE DEVICES**.
- 11 Scroll through the list and select RS507.
The device connects to the RS507 and **Connected** appears below the device name. The Bluetooth device is added to the **Bluetooth devices** list and a trusted (“paired”) connection is established.



DataWedge

DataWedge is a utility that adds advanced bar code scanning capability to any application without writing code. It runs in the background and handles the interface to built-in bar code scanners. The captured bar code data is converted to keystrokes and sent to the target application as if it was typed on the keypad.

To configure DataWedge refer to the *TC70 Integrator Guide*.

Enabling DataWedge





Procedure:

- 1 Touch .
- 2 Touch .
- 3 Touch .

- 4 Touch **Settings**.
- 5 Touch the **DataWedge enabled** checkbox. A blue checkmark appears in the checkbox indicating that DataWedge is enabled.
- 6 Touch .

Disabling DataWedge

Procedure:

- 1 Touch .
- 2 Touch .
- 3 Touch .
- 4 Touch **Settings**.
- 5 Touch the **DataWedge enabled** checkbox. The blue checkmark disappears from the checkbox indicating that DataWedge is disabled.
- 6 Touch .

Chapter 5

Wireless

This section provides information on the wireless features:

- Wireless Local Area Network (WLAN)
- Bluetooth
- Near Field Communications (NFC)

Wireless Local Area Networks

Wireless local area networks (WLANs) allow the TC70 to communicate wirelessly inside a building. Before using the TC70 on a WLAN, the facility must be set up with the required hardware to run the WLAN (sometimes known as infrastructure). The infrastructure and the TC70 must both be properly configured to enable this communication.

Refer to the documentation provided with the infrastructure (access points (APs), access ports, switches, Radius servers, etc.) for instructions on how to set up the infrastructure.

Once the infrastructure is set up to enforce the chosen WLAN security scheme, use the **Wireless & networks** settings to configure the TC70 to match the security scheme.

The TC70 supports the following WLAN security options:

- Open
- Wireless Equivalent Privacy (WEP).
- Wi-Fi Protected Access (WPA)/WPA2 Personal (PSK).
- Extensible Authentication Protocol (EAP).

The **Status** bar displays icons that indicate Wi-Fi network availability and Wi-Fi status. See [Status Bar on page 39](#) for more information.



Note: Turn off Wi-Fi when not using it, to extend the life of the battery.

Scan and Connect to a Wi-Fi Network

Procedure:

- 1 Touch .
- 2 Touch .

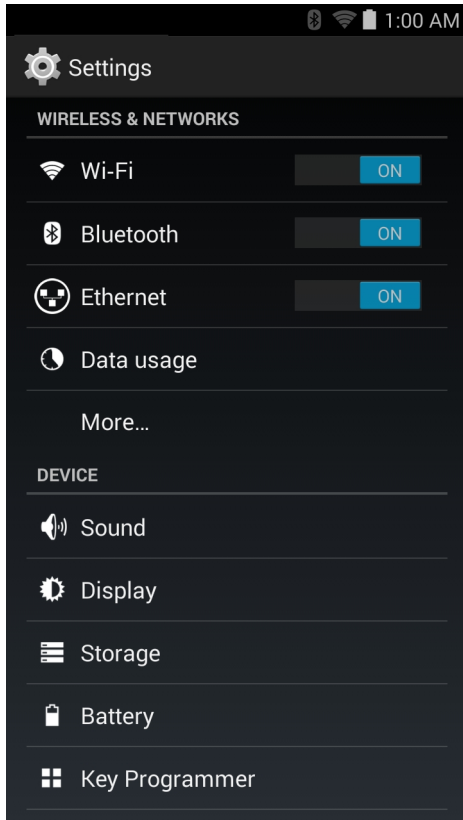
Figure 83: Settings Screen

- 3 Slide the **Wi-Fi** switch to the **ON** position.
- 4 Touch  **Wi-Fi**. The TC70 searches for WLANs in the area and lists them.

Figure 84: Wi-Fi Screen

- 5 Scroll through the list and select the desired WLAN network.
- 6 For open networks, touch profile once or press and hold and then select **Connect to network** or for secure networks enter the required password or other credentials then touch **Connect**. See the system administrator for more information.

The TC70 obtains a network address and other required information from the network using the dynamic host configuration protocol (DHCP) protocol. To configure the TC70 with a fixed internet protocol (IP) address, See [Configuring the Device to Use a Static IP Address on page 104](#).

- 7 In the Wi-Fi setting field, **Connected** appears indicating that the TC70 is connected to the WLAN.

Configuring a Wi-Fi Network

To set up a Wi-Fi network:

Procedure:



- 1 Touch .
- 2 Touch .
- 3 Touch  **Wi-Fi**.
- 4 Slide the switch to the **ON** position.
- 5 The device searches for WLANs in the area and lists them on the screen.
- 6 Scroll through the list and select the desired WLAN network.
- 7 Touch the desired network. If the network security is **Open**, the device automatically connects to the network. For all other network security a dialog box appears.

Figure 85: WLAN Network Security Dialog Box



8 If the network security is **WEP** or **WPA/WPS2 PSK**, enter the required password and then touch **Connect**.

9 If the network security is 802.1x EAP:

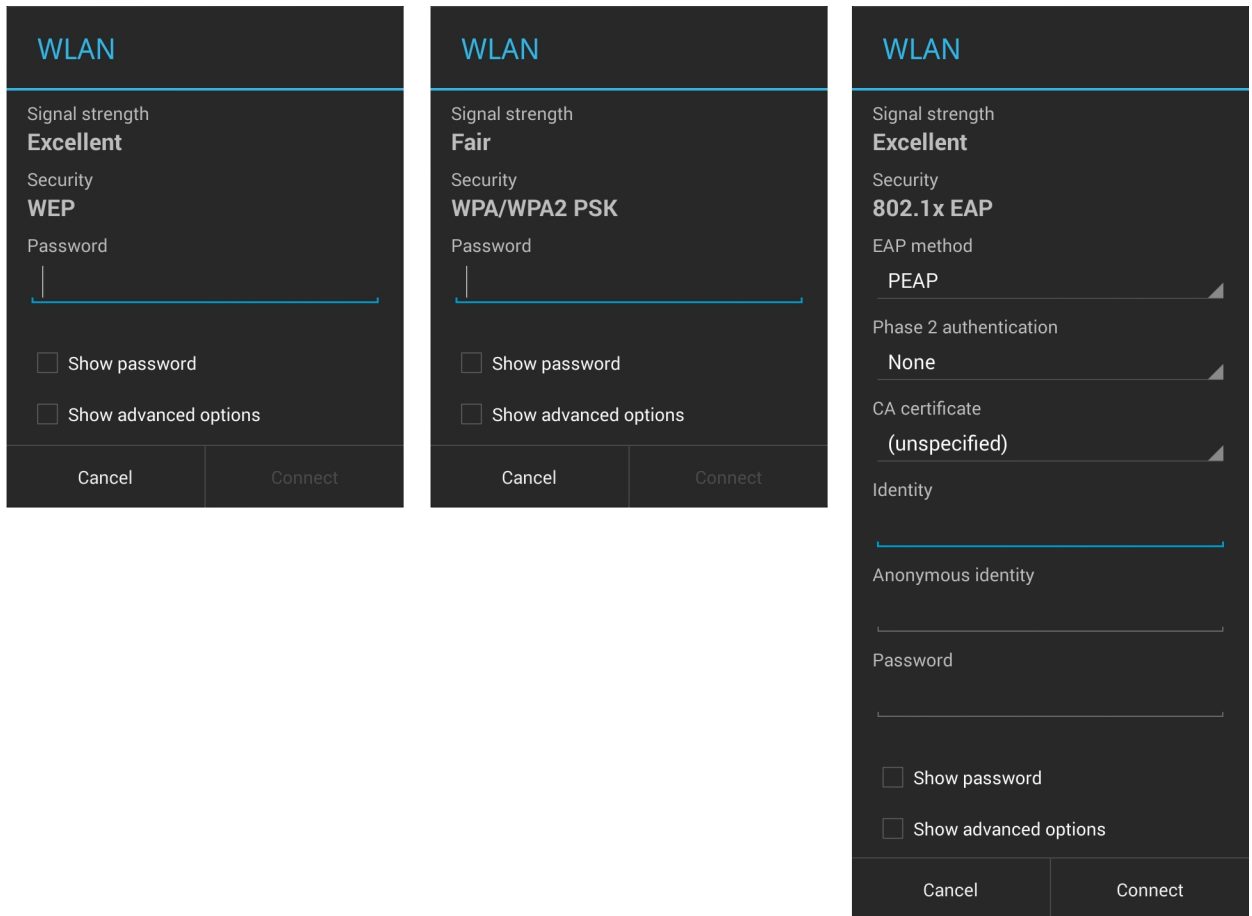
- Touch the EAP method drop-down list and select **PEAP**, **TLS**, **TTLS**, **PWD**, **LEAP** or **FAST**.
- Touch the **Phase 2 authentication** drop-down list and select an authentication method.
- If required, touch **CA certificate** and select a Certification Authority (CA) certificate. Note: Certificates are installed using the **Security** settings.
- If required, touch **User certificate** and select a user certificate. Note: User certificates are installed using the Location & security settings.
- If required, in the **Identity** text box, enter the username credentials.
- If desired, in the **Anonymous identity** text box, enter an anonymous identity username.
- If required, in the **Password** text box, enter the password for then given identity.

10  **Note:** By default, the network Proxy is set to **None** and the IP settings is set to **DHCP**. See [Configuring for a Proxy Server on page 103](#) for setting connection to a proxy server and see [Configuring the Device to Use a Static IP Address on page 104](#) for setting the device to use a static IP address.





Touch **Connect**.

11 Touch .

Manually Adding a Wi-Fi Network

Manually add a Wi-Fi network if the network does not broadcast its name (SSID) or to add a Wi-Fi network when out of range.

Procedure:

- 1 Touch .
 - 2 Touch  **Wi-Fi**.
 - 3 Slide the Wi-Fi switch to the **On** position.
 - 4 Touch + at the bottom of the screen.
 - 5 In the **Network SSID** text box, enter the name of the Wi-Fi network.
 - 6 In the **Security** drop-down list, select the type of security. Options:
 - **None**
 - **WEP**
 - **WPA/WPA2 PSK**
 - **802.1x EAP**.
 - 7 If the network security is **None**, touch **Save**.
 - 8 If the network security is **WEP** or **WPA/WPA2 PSK**, enter the required password and then touch **Save**.
 - 9 If the network security is **802.1x EAP**:
 - Touch the **EAP method** drop-down list and select **PEAP**, **TLS**, **PWD**, **TTLS**, **LEAP** or **FAST**.
 - Touch the **Phase 2 authentication** drop-down list and select an authentication method.
 - If required, touch **CA certificate** and select a Certification Authority (CA) certificate. Note: Certificates are installed using the **Security** settings.
 - If required, touch **User certificate** and select a user certificate. Note: User certificates are installed using the **Security** settings.
 - If required, in the **Identity** text box, enter the username credentials.
 - If desired, in the **Anonymous** identity text box, enter an anonymous identity username.
 - If required, in the **Password** text box, enter the password for then given identity.
 - 10  **Note:** By default, the network Proxy is set to **None** and the IP settings is set to **DHCP**. See [Configuring for a Proxy Server on page 103](#) for setting connection to a proxy server and see [Configuring the Device to Use a Static IP Address on page 104](#) for setting the device to use a static IP address.
- Touch **Save**. To connect to the saved network, touch and hold on the saved network and select **Connect to network**.
- 11 Touch .

Configuring for a Proxy Server

A proxy server is a server that acts as an intermediary for requests from clients seeking resources from other servers. A client connects to the proxy server, requesting some service, such as a file, connection, web page, or other resource, available from a different server. The proxy server evaluates the request according to its filtering rules. For example, it may filter traffic by IP address or protocol. If the request is validated by the filter, the proxy provides the resource by connecting to the relevant server and requesting the service on behalf of the client.

It is important for enterprise customers to be able to set up secure computing environments within their companies, and proxy configuration is an essential part of doing that. Proxy configuration acts as a security barrier ensuring that the proxy server monitors all traffic between the Internet and the intranet. This is normally an integral part of security enforcement in corporate firewalls within intranets.

Procedure:

- 1 In the network dialog box, touch a network.

- 2 Touch **Show advanced options** checkbox.
- 3 Touch **Proxy settings** and select **Manual**.

Figure 86: Proxy Settings

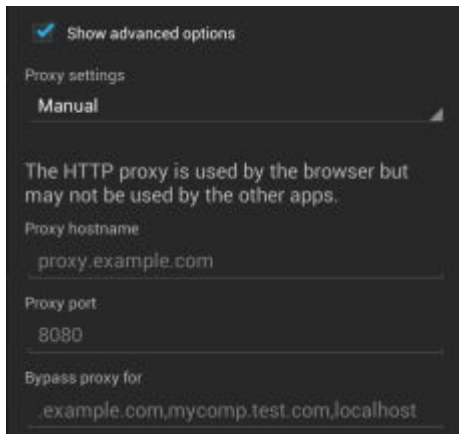

- 4 In the **Proxy hostname** text box, enter the address of the proxy server.
- 5 In the **Proxy port** text box, enter the port number for the proxy server.



Note: When entering proxy addresses the **Bypass proxy for** field, do not use spaces or carriage returns between addresses.

- 6 In the **Bypass proxy for** text box, enter addresses for web sites that do not require to go through the proxy server. Use a comma “,” between addresses.
- 7 Touch **Connect**.
- 8 Touch .

Configuring the Device to Use a Static IP Address

By default, the device is configured to use Dynamic Host Configuration Protocol (DHCP) to assign an Internet protocol (IP) address when connecting to a wireless network. To configure the device to connect to a network using a static IP address:

Procedure:

- 1 In the network dialog box, touch a network.
- 2 Touch **Show advanced options** checkbox.
- 3 Touch **IP settings** and select **Static**.

Figure 87: Static IP Settings

- 4 In the **IP address** text box, enter an IP address for the device.
- 5 If required, in the **Gateway** text box, enter a gateway address for the device.
- 6 If required, in the **Network prefix length** text box, enter a the prefix length.
- 7 If required, in the **DNS 1** text box, enter a Domain Name System (DNS) address.
- 8 If required, in the **DNS 2** text box, enter a DNS address.
- 9 Touch **Connect**.
- 10 Touch .

Advanced Wi-Fi Settings



Note: Advanced Wi-Fi settings are for the device not for a specific wireless network.

Use the **Advanced** settings to configure additional Wi-Fi settings. From the **Wi-Fi** screen, touch  > **Advanced** to view the advanced settings.

- **General**

- **Network notification** - When enabled, notifies the user when an open network is available.
- **Keep Wi-Fi on during sleep** - Opens a menu to set whether and when the Wi-Fi radio turns off.
 - + **Always On** - The radio stays on when the device enters suspend mode (default).
 - + **Only when plugged in** - The radio stays on while the device is connected to external power.
 - + **Never On** - The radio turns off when the device enters suspend mode.
- **Install Certificates** – Touch to install certificates.
- **Wi-Fi optimization** – Touch to minimize battery usage when Wi-Fi is on (default – disabled)
- **MAC address** - Displays the Media Access Control (MAC) address of the device when connecting to Wi-Fi networks.

- **Regulatory**

- **Country selection** - Displays the acquired country code if 802.11d is enabled else it displays the currently selected country code.

- **Band and Channel Selection**

- **Wi-Fi frequency band** - Use to select the frequency band. Options: **Auto** (default), **5 GHz only** or **2.4 GHz only**.
- **Available channels (2.4 GHz)** - Use to select specific channels. Touch to display the **Available channels** menu. Select specific channels. Touch **OK**.

- **Available channels (5 GHz)** - Use to select specific channels. Touch to display the **Available channels** menu. Select specific channels. Touch **OK**.
- **Logging**
 - **Advanced Logging** – Touch to enable advanced logging. Advanced logging
 - **Wireless logs** - Use to capture Wi-Fi log files.
 - + **Fusion Logger** - Touch to open the **Fusion Logger** application. This application maintains a history of high level WLAN events which helps to understand the status of connectivity.

Figure 88: Fusion Logger Screen

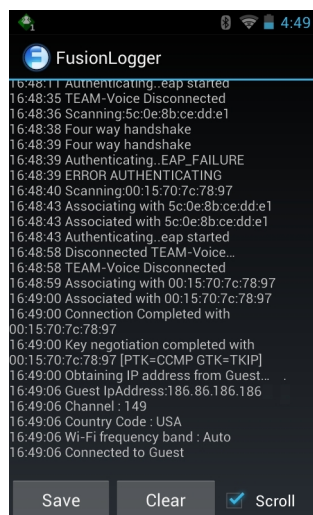

- + **Fusion Status** - Touch to display live status of WLAN state. Also provides information of device and connected profile.

Figure 89: Fusion Status Screen

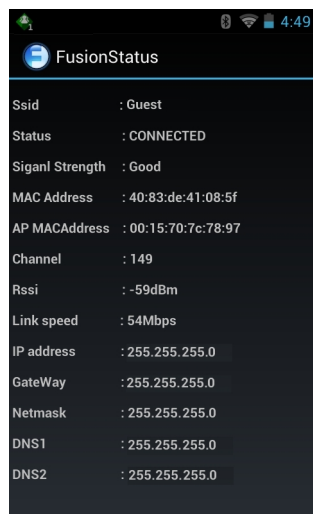





- **About**
 - **Version** - Displays the current Fusion information.

Remove a Wi-Fi Network

To remove a remembered or connected network:

Procedure:

- 1 Touch .
- 2 Touch .
- 3 Touch  **Wi-Fi**.
- 4 In the **Wi-Fi networks** list, touch and hold the name of the network.
- 5 In the menu, touch **Forget network**.
- 6 Touch .

Bluetooth

Bluetooth-equipped devices can communicate without wires, using frequency-hopping spread spectrum (FHSS) radio frequency (RF) to transmit and receive data in the 2.4 GHz Industry Scientific and Medical (ISM) band (802.15.1). Bluetooth wireless technology is specifically designed for short-range (10 meters (32.8 feet)) communication and low power consumption.

Devices with Bluetooth capabilities can exchange information (e.g., files, appointments, and tasks) with other Bluetooth enabled devices such as printers, access points, and other mobile devices.

The TC70 support Bluetooth Low Energy. Bluetooth Low Energy is targeted at applications in the healthcare, fitness, security, and home entertainment industries. It provides reduced power consumption and cost while maintaining standard Bluetooth range.

Adaptive Frequency Hopping

Adaptive Frequency Hopping (AFH) is a method of avoiding fixed frequency interferers, and can be used with Bluetooth voice. All devices in the piconet (Bluetooth network) must be AFH-capable in order for AFH to work. There is no AFH when connecting and discovering devices. Avoid making Bluetooth connections and discoveries during critical 802.11b communications. AFH for Bluetooth consists of four main sections:

- Channel Classification - A method of detecting an interference on a channel-by-channel basis, or pre-defined channel mask.
- Link Management - Coordinates and distributes the AFH information to the rest of the Bluetooth network.
- Hop Sequence Modification - Avoids interference by selectively reducing the number of hopping channels.
- Channel Maintenance - A method for periodically re-evaluating the channels.

When AFH is enabled, the Bluetooth radio “hops around” (instead of through) the 802.11b high-rate channels. AFH coexistence allows Enterprise devices to operate in any infrastructure.

The Bluetooth radio in this device operates as a Class 2 device power class. The maximum output power is 2.5 mW and the expected range is 10 meters (32.8 ft.). A definition of ranges based on power class is difficult to obtain due to power and device differences, and whether one measures open space or closed office space.



Note: It is not recommended to perform Bluetooth wireless technology inquiry when high rate 802.11b operation is required.

Security

The current Bluetooth specification defines security at the link level. Application-level security is not specified. This allows application developers to define security mechanisms tailored to their specific need. Link-level security occurs

between devices, not users, while application-level security can be implemented on a per-user basis. The Bluetooth specification defines security algorithms and procedures required to authenticate devices, and if needed, encrypt the data flowing on the link between the devices. Device authentication is a mandatory feature of Bluetooth while link encryption is optional.

Pairing of Bluetooth devices is accomplished by creating an initialization key used to authenticate the devices and create a link key for them. Entering a common personal identification number (PIN) in the devices being paired generates the initialization key. The PIN is never sent over the air. By default, the Bluetooth stack responds with no key when a key is requested (it is up to user to respond to the key request event). Authentication of Bluetooth devices is based-upon a challenge-response transaction. Bluetooth allows for a PIN or passkey used to create other 128-bit keys used for security and encryption. The encryption key is derived from the link key used to authenticate the pairing devices. Also worthy of note is the limited range and fast frequency hopping of the Bluetooth radios that makes long-distance eavesdropping difficult.

Recommendations are:

- Perform pairing in a secure environment
- Keep PIN codes private and do not store the PIN codes in the device
- Implement application-level security.

Bluetooth Profiles

The device supports the following Bluetooth services:

- Service Discovery Protocol (SDP) - Handles the search for known and specific services as well as general services.
- Serial Port Profile (SPP) - Allows use of RFCOMM protocol to emulate serial cable connection between two Bluetooth peer devices. For example, connecting the device to a printer.
- Object Push Profile (OPP) - Allows the device to push and pull objects to and from a push server.
- Advanced Audio Distribution Profile (A2DP) - Allows the device to stream stereo-quality audio to a wireless headset or wireless stereo speakers.
- Audio/Video Remote Control Profile (AVRCP) - Allows the device to control A/V equipment to which a user has access. It may be used in concert with A2DP.
- Personal Area Network (PAN) - Allows the use of Bluetooth Network Encapsulation Protocol to provide L3 networking capabilities over a Bluetooth link. Only PANU role is supported.
- Human Interface Device Profile (HID) - Allows Bluetooth keyboards, pointing devices, gaming devices and remote monitoring devices to connect to the device.
- Headset Profile (HSP) - Allows a hands-free device, such as a Bluetooth headset, to place and receive calls on the device.
- Hands-Free Profile (HFP) - Allows car hands-free kits to communicate with the device in the car.
- Dial-up Networking (DUN) - Allows the device to access the Internet and other dial-up services using a Bluetooth enabled mobile phone.
- Out of Band (OOB) - Allows exchange of information used in the pairing process. Pairing is completed using the Bluetooth radio, but requires information from the OOB mechanism. Using OOB with NFC enables pairing when devices simply get close, rather than requiring a lengthy discovery process.

Bluetooth Power States

The Bluetooth radio is off by default.

- **Suspend** - When the TC70 goes into suspend mode, the Bluetooth radio stays on.
- **Airplane Mode** - When the TC70 is placed in Airplane Mode, the Bluetooth radio turns off. When Airplane mode is disabled, the Bluetooth radio returns to the prior state. When in Airplane Mode, the Bluetooth radio can be turned back on if desired.

Bluetooth Radio Power





Turn off the Bluetooth radio to save power or if entering an area with radio restrictions (e.g., an airplane). When the radio is off, other Bluetooth devices cannot see or connect to the device. Turn on the Bluetooth radio to exchange information with other Bluetooth devices (within range). Communicate only with Bluetooth radios in close proximity.



Note: To achieve the best battery life turn off radios when not in use.



Enabling Bluetooth

Procedure:

- 1 Touch .
- 2 Touch .
- 3 Slide the Bluetooth switch to the **ON** position.  also appears in the Status bar.
- 4 Touch .

Disabling Bluetooth

Procedure:

- 1 Touch .
- 2 Touch .
- 3 Slide the Bluetooth switch to the **OFF** position.
- 4 Touch .

Discovering Bluetooth Device(s)

The TC70 can receive information from discovered devices without pairing. However, once paired, the TC70 and a paired device exchange information automatically when the Bluetooth radio is on. To find Bluetooth devices in the area:

Procedure:



- 1 Ensure that Bluetooth is enabled on both devices.
- 2 Ensure that the Bluetooth device to discover is in discoverable mode.
- 3 Ensure that the two devices are within 10 meters (32.8 feet) of one another.
- 4 Touch .
- 5 Touch .
- 6 Touch  **Bluetooth**.
- 7 Touch **SCAN FOR DEVICES**. The TC70 begins searching for discoverable Bluetooth devices in the area and displays them under **AVAILABLE DEVICES**.
- 8 Scroll through the list and select a device. The **Bluetooth pairing request** dialog box appears.





Figure 90: Bluetooth Pairing - Enter PIN**Figure 91: Bluetooth Pairing - Smart Pairing**

- 9 Enter a PIN in the text box and touch **OK**. Enter the same PIN on the other device.
- 10 For Simple Pairing, touch **Pair** on both devices.
- 11 The Bluetooth device is added to the **Bluetooth devices** list and a trusted (“paired”) connection is established.

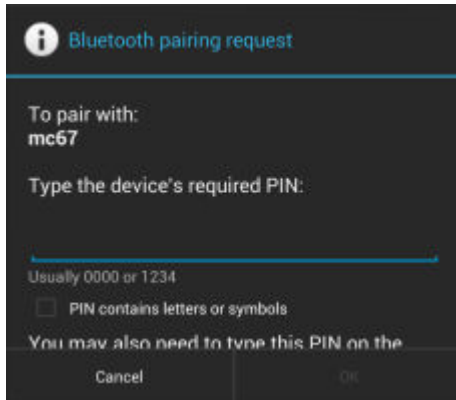
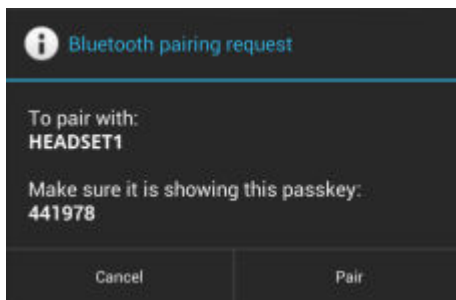
Changing the Bluetooth Name

By default, the TC70 has a generic Bluetooth name that is visible to other devices when connected.

Procedure:



- 1 Touch .
- 2 Touch .
- 3 Touch  **Bluetooth**.
- 4 If Bluetooth is not on, slide the switch to the **ON** position.
- 5 Touch .
- 6 Touch **Rename device**.
- 7 Enter a name and touch **Done**.
- 8 Touch .

Connecting to a Bluetooth Device

Once paired, connect to a Bluetooth device.

Procedure:





- 1 Touch .

- 2 Touch .
- 3 Touch  **Bluetooth**.
- 4 If Bluetooth is not on, slide the switch to the **ON** position.
- 5 In the **PAIRED DEVICES** list, touch and hold on a unconnected Bluetooth device until a menu appears.
- 6 Touch **Connect**. When connected, the device is displayed as connected in the list.

Selecting Profiles on the Bluetooth Device

Some Bluetooth devices have multiple profiles. To select a profile:





Procedure:

- 1 Touch .
- 2 Touch .
- 3 Touch  **Bluetooth**.
- 4 In the **PAIRED DEVICES** list, touch  next to the device name.
- 5 Under **PROFILES**, check or uncheck a profile to allow the device to use that profile.
- 6 Touch .

Unpairing a Bluetooth Device

To unpair a Bluetooth device and erase all pairing information:

Procedure:

- 1 Touch .
- 2 Touch .
- 3 Touch  **Bluetooth**.
- 4 In the **PAIRED DEVICES** list, touch  next to the device name.
- 5 Touch **Unpair**.
- 6 Touch .

Near Field Communications

NFC/HF RFID is a short-range wireless connectivity technology standard that enables secure transaction between a reader and a contactless smartcard. The technology is based on ISO/IEC 14443 type A and B (proximity) and ISO/IEC 15693 (vicinity) standards, using the HF 13.56 MHz unlicensed band. The TC70 support 3 operating modes:

- Reader mode
- Peer-to-Peer communication
- Card Emulation mode.

Using NFC, the TC70 can:

- Read contactless cards such as contactless tickets, ID cards and ePassport.
- Read and write information to contactless cards such as SmartPosters and tickets, as well as devices with NFC interface such as vending machines.

- Read information from supported medical sensors.
- Pair with supported Bluetooth devices such as printers and headsets.
- Exchange data with another NFC device.
- Emulate contactless card such as payment, ticket or SmartPoster.

The TC70 NFC antenna is uniquely positioned to read NFC cards from the top of the device while being held in the user's hand.

Reading NFC Cards

Procedure:

- 1 Launch an NFC enabled application.
- 2 Hold device as shown.

Figure 92: Reading Cards

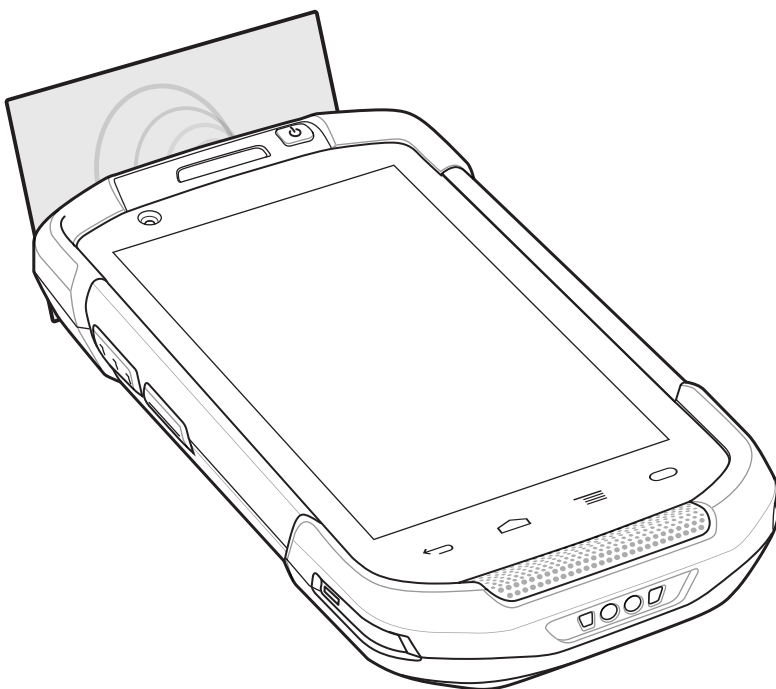

- 3 Move TC70 close to the NFC card until the TC70 detects the card.
- 4 Hold the card steadily until the transaction is complete (usually indicated by the application).

Sharing Information Using NFC

You can beam content like a web page, contact cards, pictures, YouTube links or location information from your screen to another device by bringing the devices together back to back.

Prerequisites: Make sure both devices are unlocked, support NFC, and have both NFC and Android Beam turned on.

Procedure:

- 1 Open a screen that contains a web page, video, photo or contact.
- 2 Move the top of the TC70 toward the top of the other device.

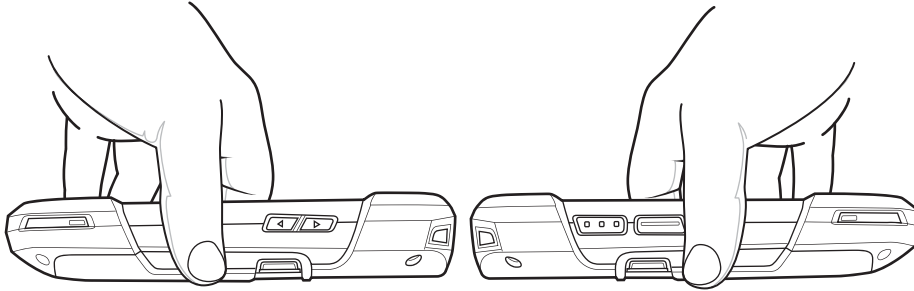
Figure 93: Sharing Data Using NFC

When the devices connect, you hear a sound, the image on the screen reduces in size, the message **Touch to beam** appears.

- 3 Touch anywhere on the screen.
The transfer begins.

Enterprise NFC Settings

The Enterprise NFC Settings provides advanced configuration of the NFC radio.

To configure the NFC settings, touch **Settings** > **More ...** > **Enterprise NFC Settings**.

Figure 94: Wireless & Networks Screen

Figure 95: Enterprise NFC Settings Screen

- **Reader Mode** – Touch to open the Reader Mode setting screen.
- **Enable P2P mode** – Enable or disable peer to peer mode. Default: Enabled.
- **Card Emulation Mode** – Enable or disable card emulation mode. Default: Disabled.
- **Enable CE mode** – Touch to enable or disable card emulation mode. Default: Enabled.
- **Enable NFC on Lock Screen** – Enable or disable NFC on lock screen.
- **Reset to Default** – Reset all NFC settings to factory default settings.

Reader Mode

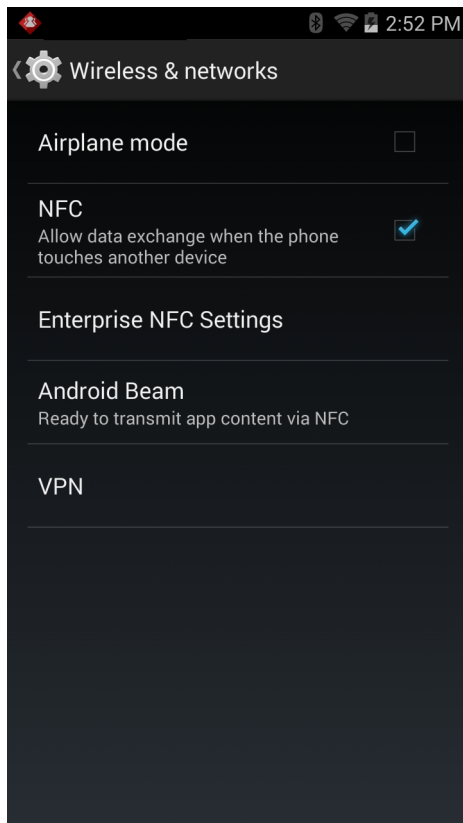
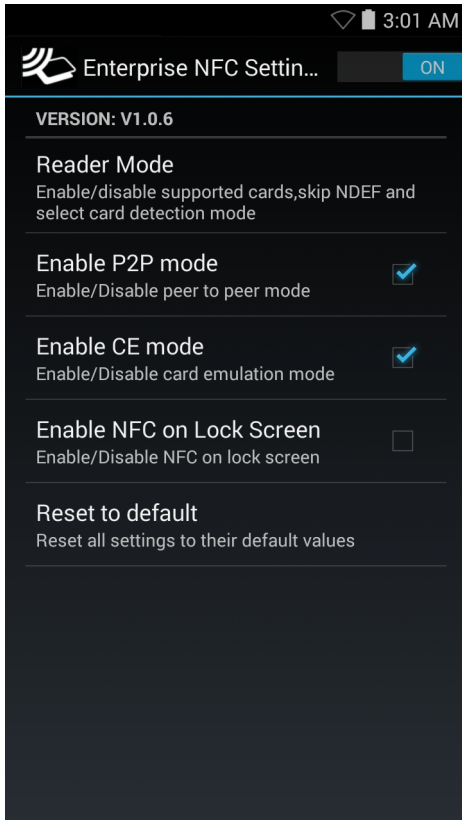

Use the **Reader Mode** settings to configure the NFC radio.

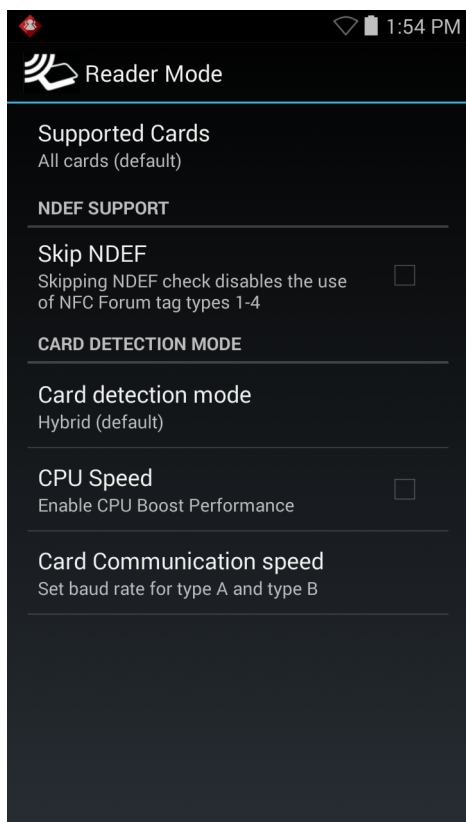
Figure 96: Reader Mode Settings



- **Supported Cards** – Touch to select the type of NFC cards to support. Options: **All Cards** (default), **Type A**, **Type B**, **Type F** or **Type V**.
- **NDEF Support**
 - **Skip NDEF** – Enables or disables the use of NFC Forum tag types 1 through 4. Default: Disabled.
- **Card Detection Mode**
 - **Card detection mode** – Touch to select the card detection mode. Options: **Low power**, **Standard** or **Hybrid** (default).
 - **CPU Speed** – Touch to enhance NFC transaction performance while reading small amounts data. Default: Enabled.
 - **Card Communication speed** – Touch to set the baud rate for type A and type B cards. Options: **106 kbps** (default for Type A), **212 kbps**, **424 kbps** or **No restrictions** (default for Type B).

Data Usage

Data usage refers to the amount of data uploaded or downloaded by the device during a given period. To monitor data usage, go to  >  **Data usage**.

Data usage settings allow you to:

- View or restrict data usage by application.
- Identify mobile hotspots and restrict background downloads that may result in extra charges.
- View data usage for Wi-Fi networks.

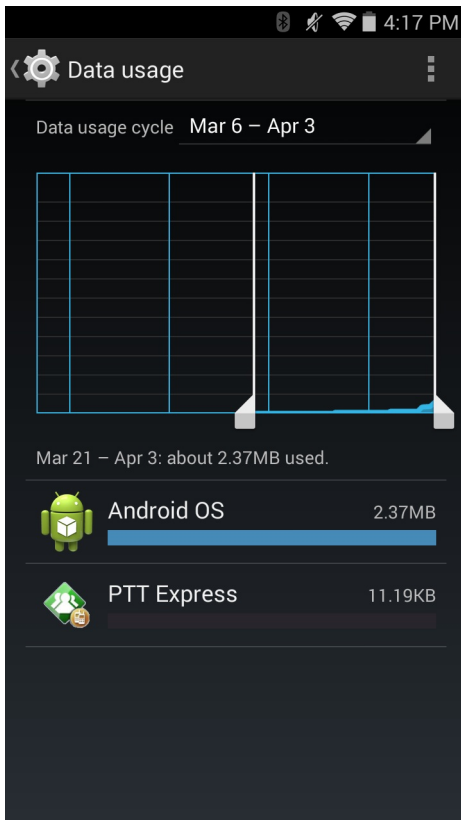
Figure 97: Data Usage Screen

Touch the data usage cycle to choose a different cycle. This date range is the period of time for which the graph displays data usage.

The vertical white lines on the graph show a period of time within the data usage cycle. This range determines the usage amount displayed just below the graph. Drag lines to change the period.

Below the graph is a list of applications that used data.

Set Auto-Sync

You can also conserve data usage by syncing your applications manually, only when you need the data, rather than relying on auto-sync. To turn auto-sync off or on, touch  > **Auto-sync data**.

Chapter 6

Accessories

This chapter provides information for using the accessories for the device.

Accessories

This table lists the accessories available for the TC70.

Table 12: TC70 Accessories

Accessory	Part Number	Description
Cradles		
2-Slot Charge Only Cradle	CRD-TC7X-SEC2U1-01	Provides device and spare battery charging. Use with power supply, p/n PWRS-14000-148R.
2-Slot USB/Ethernet Cradle	CRD-TC7X-SE2EU1-01	Provides device and spare battery charging and USB communication with a host computer and Ethernet communication with a network. Use with power supply, p/n PWRS-14000-148R.
5-Slot Charge Only Cradle	CRD-TC7X-SE5C1-01	Charges up to five devices. Use with power supply, p/n PWRS-14000-241R and DC line cord, p/n 50-16002-029R. Can accommodate one 4-Slot Battery Charger using the Battery Adapter Cup.
5-Slot Ethernet Cradle	CRD-TC7X-SE5EU1-01	Provides device charging and provides Ethernet communication for up to five devices. Use with power supply, p/n PWRS-14000-241R and DC line cord, p/n 50-16002-029R. Can accommodate one 4-Slot Battery Charger using the Battery Adapter Cup.
Cradle Mount	BRKT-SCRD-SMRK-01	Mounts the 5-Slot Charge Only Cradle, 5-Slot Ethernet Cradle, and 4-Slot Battery Charger to a wall or rack.
Batteries and Chargers		
4,620 mAh PowerPrecision battery	BTRY-TC7X-46MA2-01	Replacement battery (single pack).
	BTRY-TC7X-46MA2-10	Replacement battery (10-pack).
4-Slot Spare Battery Charger	SAC-TC7X-4BTYC1-01	Charges up to four battery packs. Use with power supply, p/n PWRS-14000-148R.
Battery Charger Adapter Cup	CUP-SE-BTYADP1-01	Allows for one 4-Slot Battery Charger to be charged and docked on the left most slot of the 5-Slot cradles (maximum one per cradle).

Table continued...

Accessory	Part Number	Description
Payment		
Magnetic Stripe Reader	MSR-TC7X-SNP1-01	Captures data from magnetic stripe cards.
Charge and Communication Cables		
Charging Cable Cup	CHG-TC7X-CBL1-01	Provides power to the device. Use with power supply, p/n PWRS-14000-249R, sold separately.
Snap-On USB Cable	CBL-TC7X-CBL1-01	Provides power to the device and USB communication with a host computer. Use with power supply, p/n PWRS-14000-249R, sold separately.
Snap-On Serial Cable	CBL-TC7X-SERL1-01	Provides power and serial communication with a host computer. Use with power supply, p/n PWRS-14000-249R, sold separately.
Snap-On DEX Cable	CBL-TC7X-DEX1-01	Provides electronic data exchange with devices such as vending machines.
Audio Accessories		
2.5 mm Audio Adapter	ADP-TC7X-AUDIO1-01	Snaps onto the device and provides audio to a wired headset with 2.5 mm plug.
2.5 mm Headset	HDST-25MM-PTVP-01	Use for PTT and VoIP calls
Premium Headset	RCH51	Premium Rugged headset.
2.5 mm Quick Disconnect Adapter Cable	25-124387-02R	Provides connection to the RCH50/RCH51 headset.
3.5 mm Audio Adapter	ADP-TC7X-AUD35-01	Snaps onto the device and provides audio to a wired headset with 3.5 mm plug.
3.5 mm Headset	HDST-35MM-PTVP-01	Use for PTT and VoIP calls.
3.5 mm Quick Disconnect Adapter Cable	ADP-35M-QDCBL1-01	Provides connection to the 3.5 mm Headset.
Scanning		
Trigger Handle	TRG-TC7X-SNP1-01	Adds gun-style handle with a scanner trigger for comfortable and productive scanning.
Carrying Solutions		
Soft Holster	SG-TC7X-HLSTR1-01	TC7X soft holster.
Rigid Holster	SG-TC7X-RHLSTR1-01	TC7X rigid holster.
Hand Strap	SG-TC7X-HSTRP1-03	Replacement hand strap with hand strap mounting clip (3-pack).
Stylus and Coiled Tether	SG-TC7X-STYLUS-03	TC7X stylus with coiled tether (3-pack).
Power Supplies		
Power Supply	PWRS-14000-249R	Provides power to the device using the Snap-On USB Cable, Snap-on Serial Cable or Charging Cable Cup. Requires AC line cord.
Power Supply	PWRS-14000-148R	Provides power to the 2-Slot cradles and 4-Slot Spare Battery Charger. Requires AC line cord.

Table continued...

Accessory	Part Number	Description
Power Supply	PWRS-14000-241R	Provides power to the 5-Slot Charge Only cradle and the 5-Slot Ethernet Cradle. Requires DC Line Cord, p/n 50-16002-029R and country specific three wire grounded AC line cord sold separately.
DC Line Cord	50-16002-029R	Provides power from the power supply to the 5-Slot Charge Only Cradle and 5-Slot Ethernet Cradle.

2-Slot Charge Only Cradle

The 2-Slot Charge Only Cradle:

- Provides 5 VDC power for operating the device.
- Charges the device's battery.
- Charges a spare battery.

Figure 98: 2-Slot Charge Only Cradle

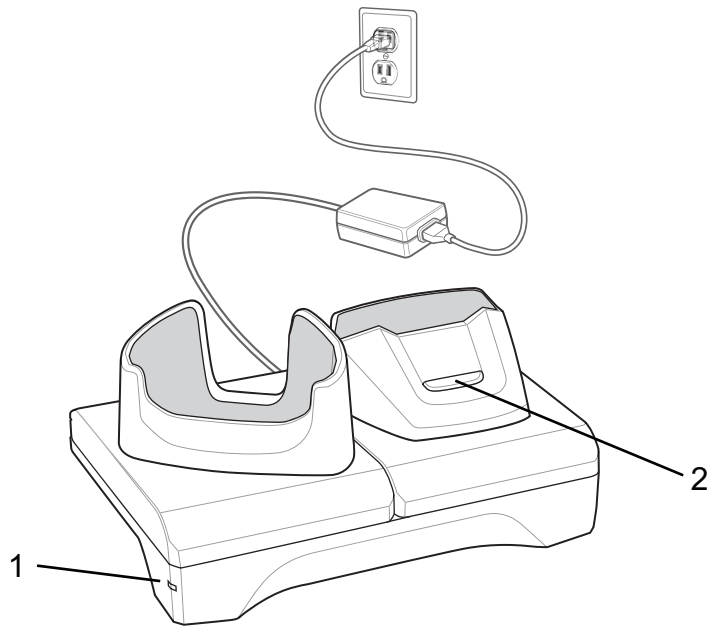

1	Power LED – Lights green indicating that the cradle is receiving power.
2	Spare battery Charging LED

Charging the Device

Procedure:

- 1 Insert the device into the slot to begin charging.

Figure 99: Battery Charging

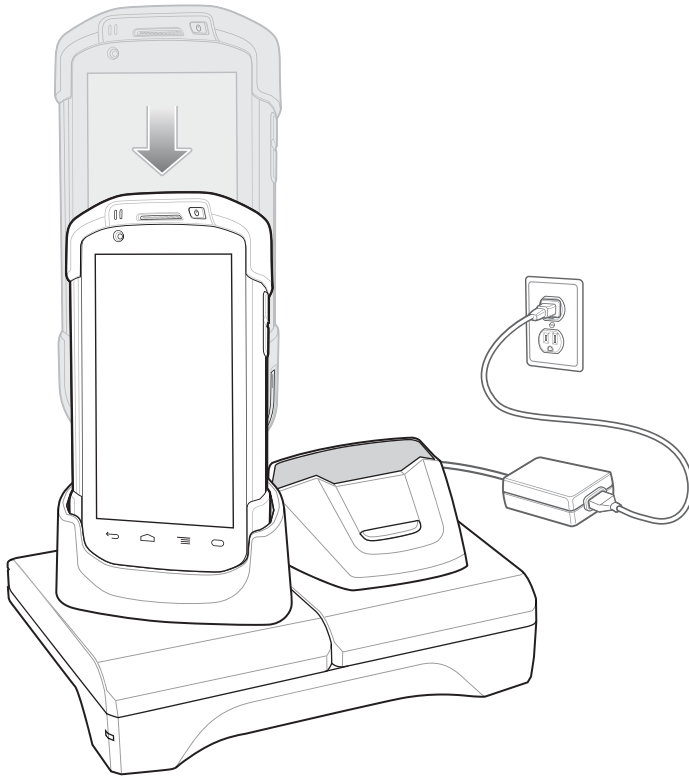

- 2 Ensure the device is seated properly.

Charging the Spare Battery

Procedure:

- 1 Insert the battery into the right slot to begin charging.

Figure 100: Spare Battery Charging

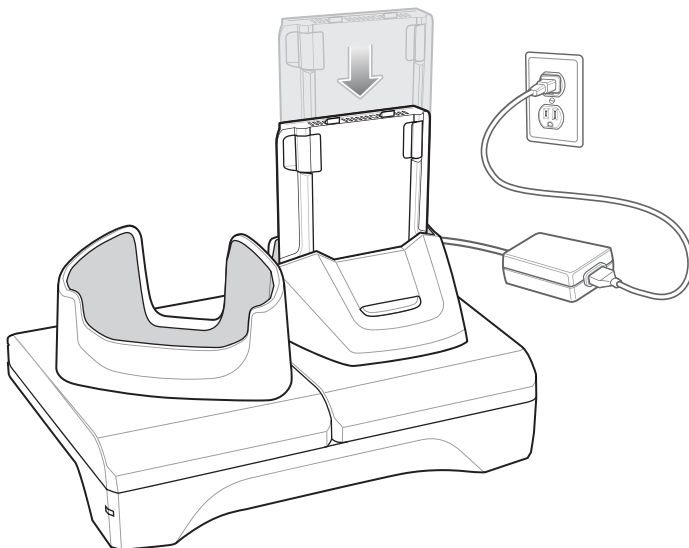

- 2 Ensure the battery is seated properly.

Battery Charging

Main Battery Charging

The device's Charging/Notification LED indicates the status of the battery charging in the device.

The 4,620 mAh battery fully charges in less than six hours at room temperature.

Spare Battery Charging

The Spare battery Charging LED on the cup indicates the status of the spare battery charging.

The 4,620 mAh battery fully charges in less than six hours at room temperature.

Table 13: Spare Battery Charging LED Indicators

LED	Indication
Slow Blinking Amber	Spare battery is charging.
Solid Green	Charging complete.
Fast Blinking Amber	Error in charging; check placement of spare battery.
Slow Blinking Red	Spare battery is charging and battery is at the end of useful life.
Solid Red	Charging complete and battery is at the end of useful life.
Fast Blinking Red	Error in charging; check placement of spare battery and battery is at the end of useful life.
Off	No spare battery in slot; spare battery not placed correctly; cradle is not powered.

Charging Temperature

Charge batteries in temperatures from 0 °C to 40 °C (32 °F to 104 °F). The device or cradle always performs battery charging in a safe and intelligent manner. At higher temperatures (e.g. approximately +37 °C (+98 °F)) the device or cradle may for small periods of time alternately enable and disable battery charging to keep the battery at acceptable temperatures. The device and cradle indicates when charging is disabled due to abnormal temperatures via its LED.

2-Slot USB/Ethernet Cradle

The 2-Slot USB/Ethernet Cradle:

- Provides 5.0 VDC power for operating the device.
- Charges the device's battery.
- Charges a spare battery.
- Connects the device to an Ethernet network.
- Provides communication to a host computer using a USB cable.

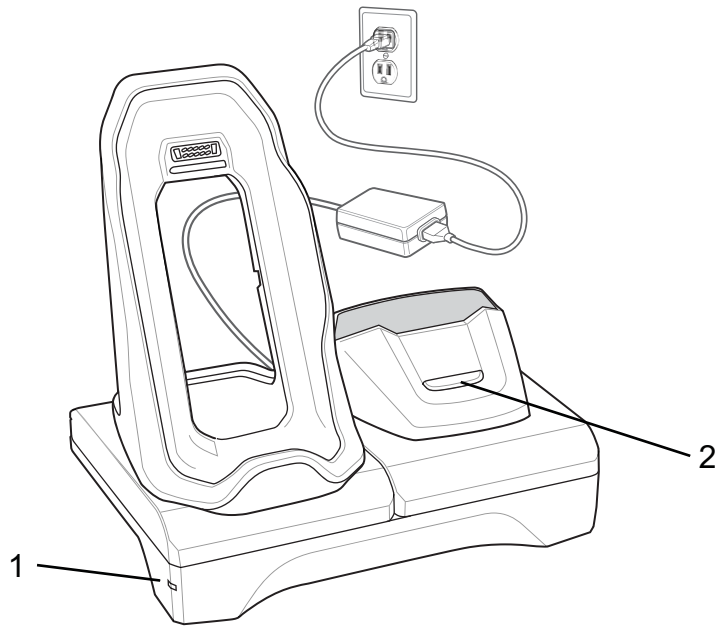

Note: Remove all attachments on the device, except the hand strap, before place onto the cradle.

Figure 101: 2-Slot USB/Ethernet Cradle

1	Power LED – Lights green indicating that the cradle is receiving power.
2	Spare Battery Charging LED

Charging the Device

Procedure:

- 1 Place the bottom of the device into the base.

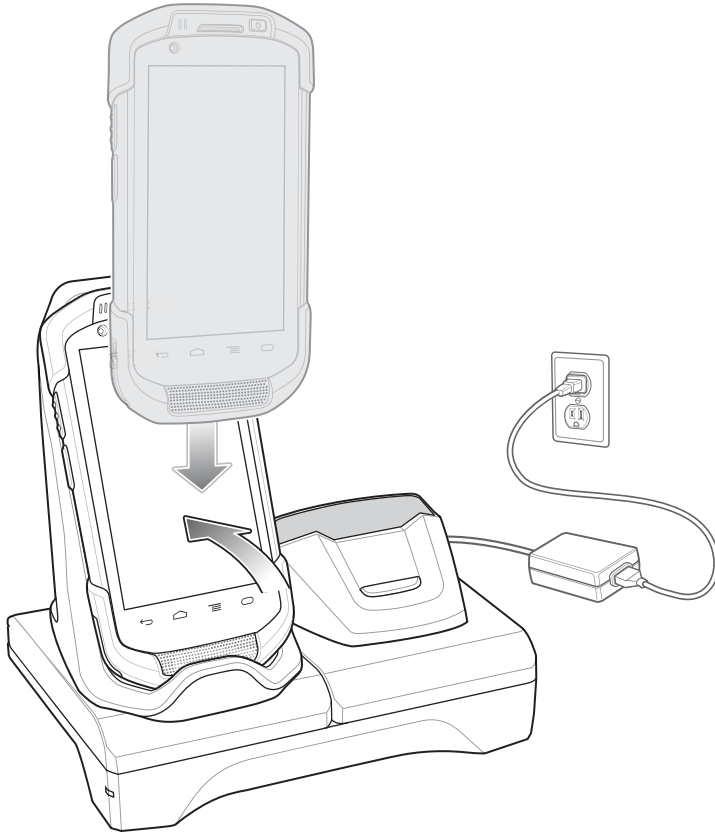
Figure 102: Battery Charging

- 2 Rotate the top of the device until the connector on the back of the device mates with the connector on the cradle.
- 3 Ensure the device is connected properly. The charging Charging/Notification LED on the device begins blinking amber indicating that the device is charging.

Charging the Spare Battery

Procedure:

- 1 Insert the battery into the right slot to begin charging.

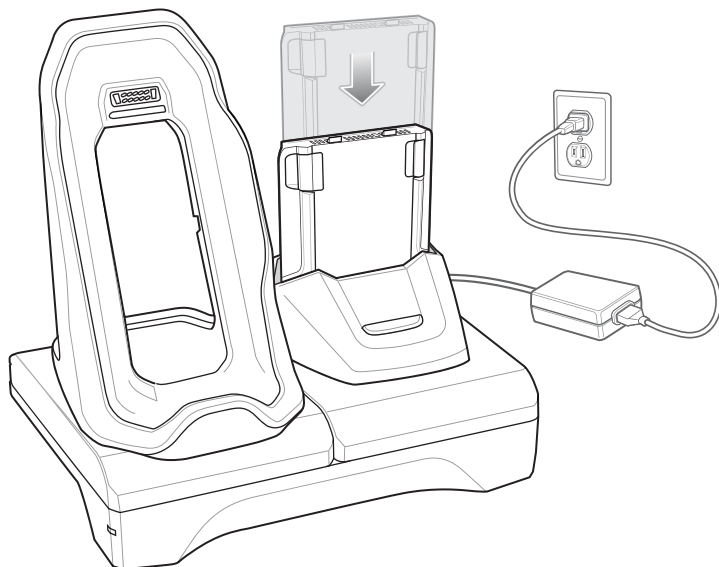
Figure 103: Spare Battery Charging

- 2 Ensure the battery is seated properly.

Battery Charging

Main Battery Charging

The device's Charging/Notification LED indicates the status of the battery charging in the device.

The 4,620 mAh battery fully charges in less than six hours at room temperature.

Spare Battery Charging

The Spare battery Charging LED on the cup indicates the status of the spare battery charging.

The 4,620 mAh battery fully charges in less than six hours at room temperature.

Table 14: Spare Battery Charging LED Indicators

LED	Indication
Slow Blinking Amber	Spare battery is charging.
Solid Green	Charging complete.
Fast Blinking Amber	Error in charging; check placement of spare battery.
Slow Blinking Red	Spare battery is charging and battery is at the end of useful life.
Solid Red	Charging complete and battery is at the end of useful life.
Fast Blinking Red	Error in charging; check placement of spare battery and battery is at the end of useful life.
Off	No spare battery in slot; spare battery not placed correctly; cradle is not powered.

Charging Temperature

Charge batteries in temperatures from 0 °C to 40 °C (32 °F to 104 °F). The device or cradle always performs battery charging in a safe and intelligent manner. At higher temperatures (e.g. approximately +37 °C (+98 °F)) the device or cradle may for small periods of time alternately enable and disable battery charging to keep the battery at acceptable temperatures. The device and cradle indicates when charging is disabled due to abnormal temperatures via its LED.

USB/Ethernet Communication

The 2-Slot USB/Ethernet Cradle provides both Ethernet communication with a network and USB communication with a host computer. Prior to using the cradle for Ethernet or USB communication. Ensure that the switch on the USB/Ethernet module is set properly.

Turn the cradle over to view the module.

Figure 104: 2-Slot USB/Ethernet Cradle Module Switch

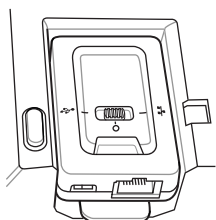

For Ethernet communication, slide the switch to the  position.

For USB communication, slide the switch to the  position.

Place the switch in the center position  to disable communications.

Ethernet LED Indicators

There are two LEDs on the USB/Ethernet Module RJ-45 connector. The green LED lights to indicate that the transfer rate is 100 Mbps. When the LED is not lit the transfer rate is 10 Mbps. The yellow LED blinks to indicate activity, or stays lit to indicate that a link is established. When it is not lit it indicates that there is no link.

Figure 105: LED Indicators

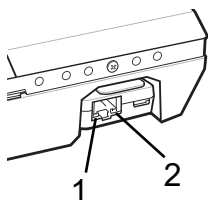

Table 15: USB/Ethernet Module LED Data Rate Indicators



Data Rate	(1) Yellow LED	(2) Green LED
100 Mbps	On/Blink	On
10 Mbps	On/Blink	Off

Establishing Ethernet Connection



Note: Refer to the *TC70 Integrator Guide* for information on configuring the Ethernet settings.

Procedure:

- 1 Touch .
- 2 Touch .
- 3 Touch **Ethernet**.
- 4 Slide the Ethernet switch to the **ON** position.
- 5 Insert the device into a slot.
The  icon appears in the Status bar.
- 6 Touch **Eth0** to view Ethernet connection details.

5-Slot Charge Only Cradle

The 5-Slot Charge Only Cradle:

- Provides 5 VDC power for operating the TC70.
- Simultaneously charges up to five TC70s and up to four TC70s and on 4-Slot Battery Charger using the Battery Charger Adapter. See the *TC70 Integrator Guide* for information on installing the 4-Slot Battery Charger onto the cradle.
- Consists of a cradle base and cups that can be configured for various charging requirements.

Figure 106: 5-Slot Charge Only Cradle

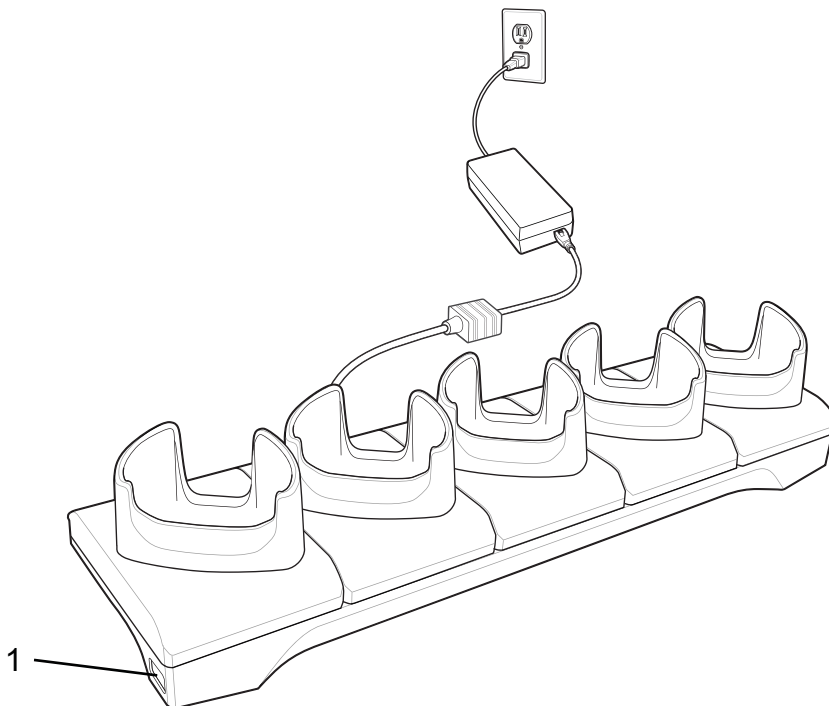

1	Power LED – Lights green when power is applied to cradle.
---	---

Charging the TC70

Procedure:

- 1 Insert the TC70 into a slot to begin charging.

Figure 107: TC70 Battery Charging

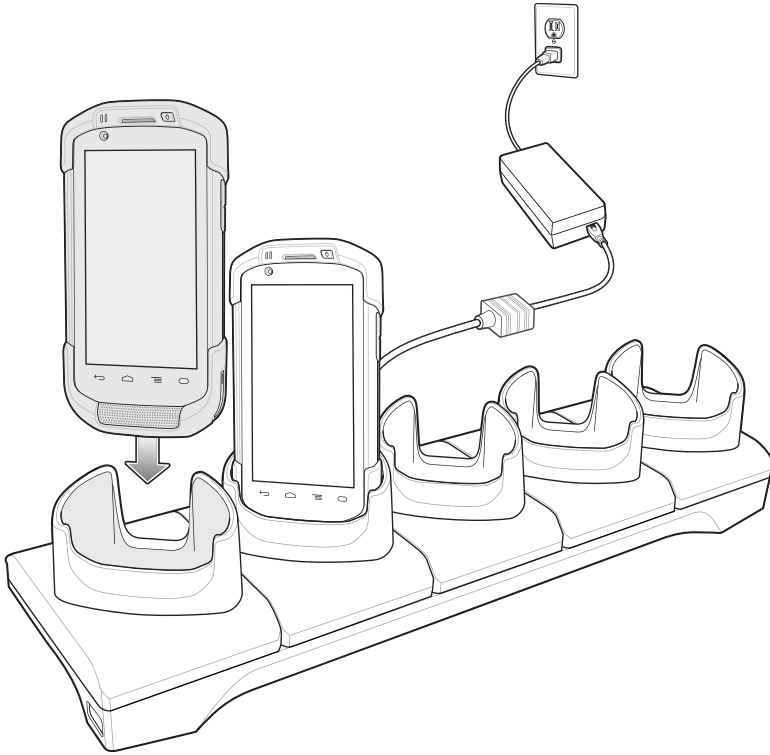
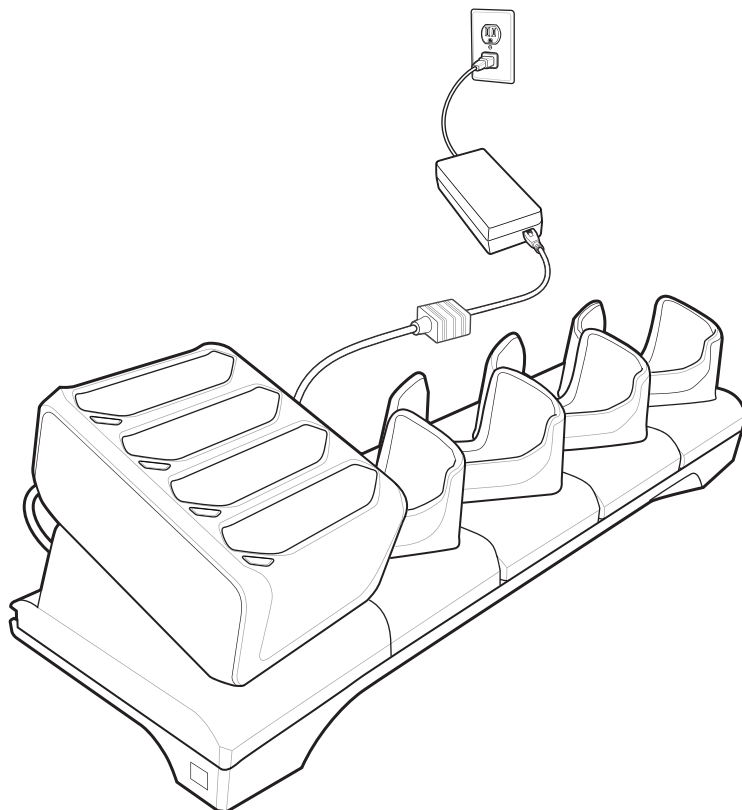

Figure 108: 5-Slot Charge Only Cradle with Four Slot Battery Charger

- 2 Ensure the TC70 is seated properly.



Note: See the *TC70 Integrator Guide* for information on installing the 4-Slot Battery Charger onto the cradle.

Battery Charging

Main Battery Charging

The device's Charging/Notification LED indicates the status of the battery charging in the device.

The 4,620 mAh battery fully charges in less than six hours at room temperature.

Spare Battery Charging

The Spare battery Charging LED on the cup indicates the status of the spare battery charging.

The 4,620 mAh battery fully charges in less than six hours at room temperature.

Table 16: Spare Battery Charging LED Indicators

LED	Indication
Slow Blinking Amber	Spare battery is charging.
Solid Green	Charging complete.
Fast Blinking Amber	Error in charging; check placement of spare battery.

Table continued...

LED	Indication
Slow Blinking Red	Spare battery is charging and battery is at the end of useful life.
Solid Red	Charging complete and battery is at the end of useful life.
Fast Blinking Red	Error in charging; check placement of spare battery and battery is at the end of useful life.
Off	No spare battery in slot; spare battery not placed correctly; cradle is not powered.

Charging Temperature

Charge batteries in temperatures from 0 °C to 40 °C (32 °F to 104 °F). The device or cradle always performs battery charging in a safe and intelligent manner. At higher temperatures (e.g. approximately +37 °C (+98 °F)) the device or cradle may for small periods of time alternately enable and disable battery charging to keep the battery at acceptable temperatures. The device and cradle indicates when charging is disabled due to abnormal temperatures via its LED.

5-Slot Ethernet Cradle



Caution: Ensure that you follow the guidelines for battery safety described in [Battery Safety Guidelines on page 155](#).

The 5-Slot Ethernet Cradle:

- Provides 5.0 VDC power for operating the device.
- Connects the device (up to five) to an Ethernet network.
- Simultaneously charges up to five TC70s and up to four TC70s and on 4-Slot Battery Charger using the Battery Charger Adapter. See the *TC70 Integrator Guide* for information on installing the 4-Slot Battery Charger onto the cradle.

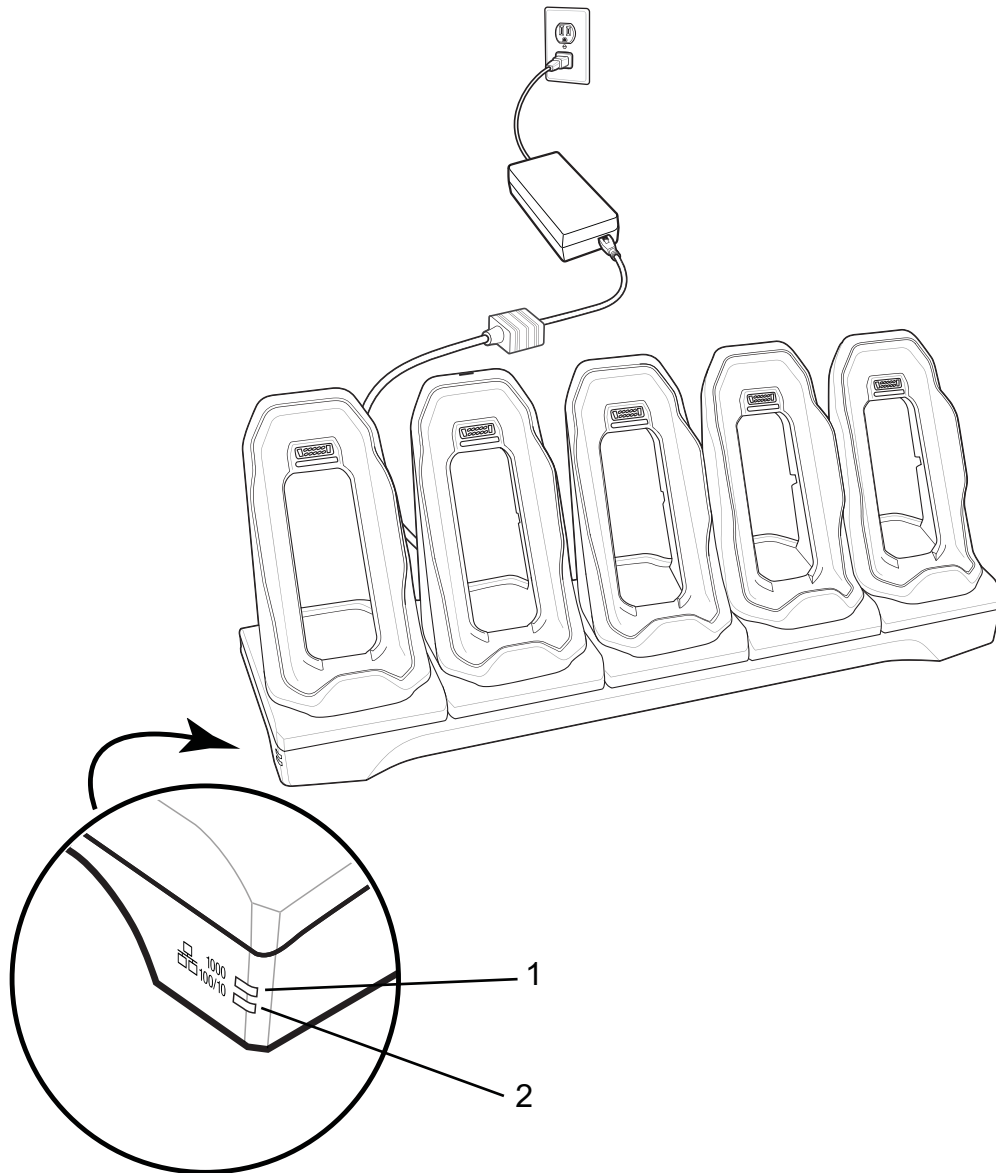
Figure 109: 5-Slot Ethernet Cradle

1	1000 LED – Indicates 1 Gbps data rate.
2	100/10 LED – Indicates 100 Mbps or 10 Mbps data rate.

Charging the TC70

Procedure:

- 1 Insert the TC70 into a slot to begin charging.

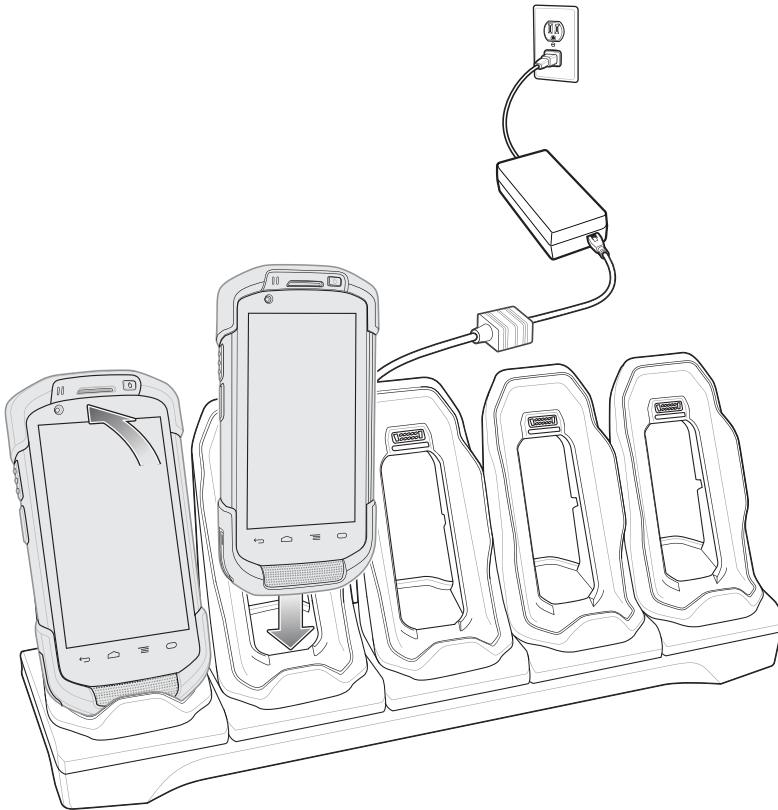
Figure 110: TC70 Battery Charging

- 2 Ensure the TC70 is seated properly.

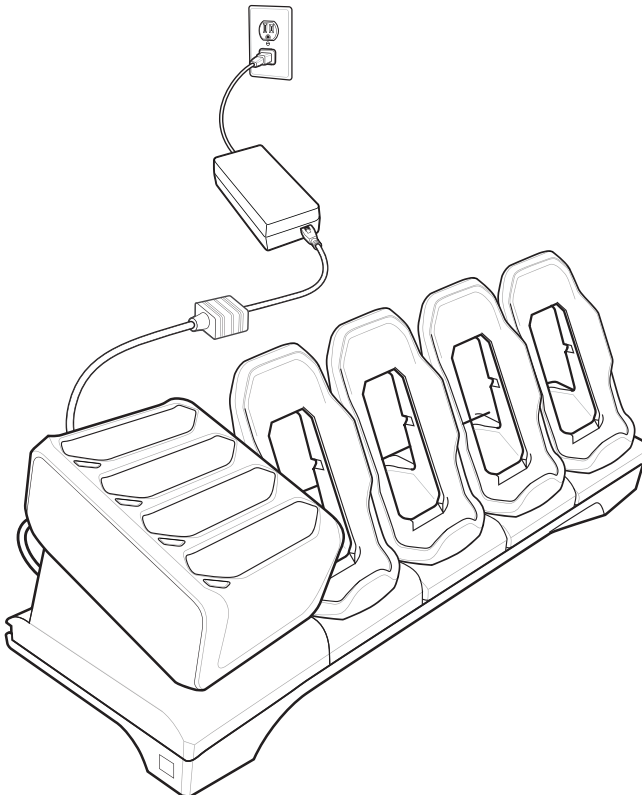
Figure 111: 5-Slot Ethernet Cradle with 4-Slot Battery Charger



Note: See the *TC70 Integrator Guide* for information on installing the 4-Slot Battery Charger onto the cradle.

Battery Charging

Main Battery Charging

The device's Charging/Notification LED indicates the status of the battery charging in the device.

The 4,620 mAh battery fully charges in less than six hours at room temperature.

Spare Battery Charging

The Spare battery Charging LED on the cup indicates the status of the spare battery charging.

The 4,620 mAh battery fully charges in less than six hours at room temperature.

Table 17: Spare Battery Charging LED Indicators

LED	Indication
Slow Blinking Amber	Spare battery is charging.
Solid Green	Charging complete.
Fast Blinking Amber	Error in charging; check placement of spare battery.
Slow Blinking Red	Spare battery is charging and battery is at the end of useful life.
Solid Red	Charging complete and battery is at the end of useful life.
Fast Blinking Red	Error in charging; check placement of spare battery and battery is at the end of useful life.
Off	No spare battery in slot; spare battery not placed correctly; cradle is not powered.

Charging Temperature



Charge batteries in temperatures from 0 °C to 40 °C (32 °F to 104 °F). The device or cradle always performs battery charging in a safe and intelligent manner. At higher temperatures (e.g. approximately +37 °C (+98 °F)) the device or cradle may for small periods of time alternately enable and disable battery charging to keep the battery at acceptable temperatures. The device and cradle indicates when charging is disabled due to abnormal temperatures via its LED.

Establishing Ethernet Connection



Note: Refer to the *TC70 Integrator Guide* for information on configuring the Ethernet settings.

Procedure:

- 1 Touch .
- 2 Touch .
- 3 Touch **Ethernet**.
- 4 Slide the Ethernet switch to the **ON** position.
- 5 Insert the device into a slot.
The  icon appears in the Status bar.

6 Touch **Eth0** to view Ethernet connection details.

LED Indicators

There are two green LEDs on the side of the cradle. These green LEDs light and blink to indicate the data transfer rate.

Table 18: LED Data Rate Indicators

Data Rate	1000 LED	100/10 LED
1 Gbps	On/Blink	Off
100 Mbps	Off	On/Blink
10 Mbps	Off	On/Blink

4-Slot Battery Charger

This section describes how to use the 4-Slot Battery Charger to charge up to four TC70 batteries.

Charging Spare Batteries

Procedure:

- 1 Connect the charger to a power source.
- 2 Insert the battery into a battery charging well and gently press down on the battery to ensure proper contact.

Figure 112: 4-Slot Battery Charger

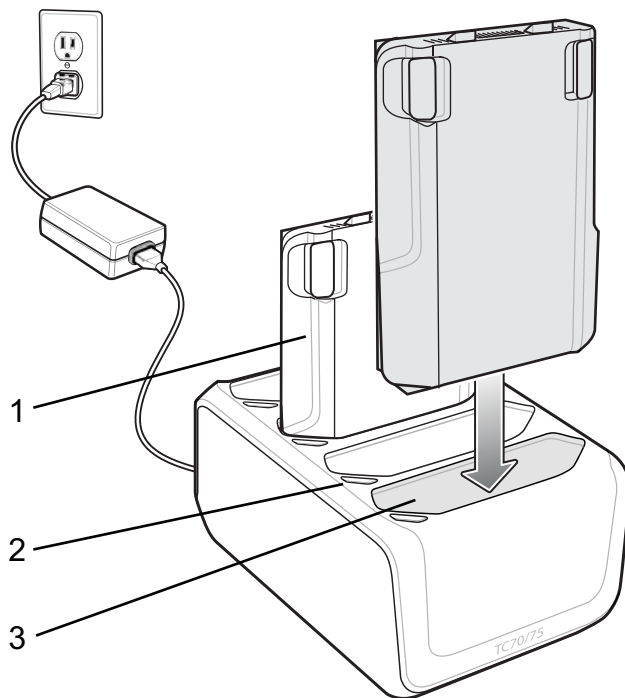

Item	Description
1	TC70 Battery
2	Battery Charge LED
3	Battery Slot

Battery Charging

Spare Battery Charging

Each Battery Charging LED indicates the status of the battery charging in each slot. The table below describes the Battery Charging LED status.

The 4,620 mAh battery fully charges in less than six hours at room temperature.

Table 19: Battery LED Charging Indicators

LED	Indication
Slow Blinking Amber	Spare battery is charging.
Solid Green	Charging complete.
Fast Blinking Amber	Error in charging; check placement of spare battery.
Slow Blinking Red	Spare battery is charging and battery is at the end of useful life.
Solid Red	Charging complete and battery is at the end of useful life.
Fast Blinking Red	Error in charging; check placement of spare battery and battery is at the end of useful life.
Off	No spare battery in slot; spare battery not placed correctly; cradle is not powered.

Charging Temperature

Charge batteries in temperatures from 0 °C to 40 °C (32 °F to 104 °F). The battery charger always performs battery charging in a safe and intelligent manner. At higher temperatures (e.g. approximately +37 °C (+98 °F)) the battery charger may for small periods of time alternately enable and disable battery charging to keep the battery at acceptable temperatures. The battery charger indicates when charging is disabled due to abnormal temperatures via its LED.

Magnetic Stripe Reader

The MSR snaps on to the back of the TC70 and removes easily when not in use. When attached to the TC70, the MSR allows the TC70 to capture data from magnetic stripe cards.

For battery optimization, remove when not in use.

Attaching the MSR

Procedure:

- 1 Align the top mounting points on the MSR with the mounting slots on the TC70.

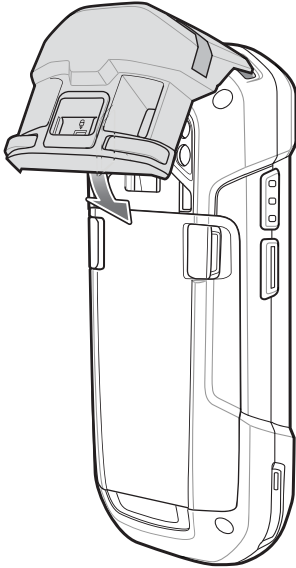
Figure 113: MSR Installation

- 2 Rotate the MSR down and press down until it snaps into position.
- 3 Using a flat end plastic tool, slide the lock switch down to lock the MSR.

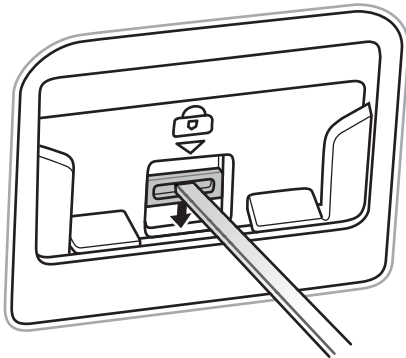
Figure 114: Lock MSR

Removing the MSR

Procedure:

- 1 Using a flat end plastic tool, slide the lock switch up to unlock the MSR.

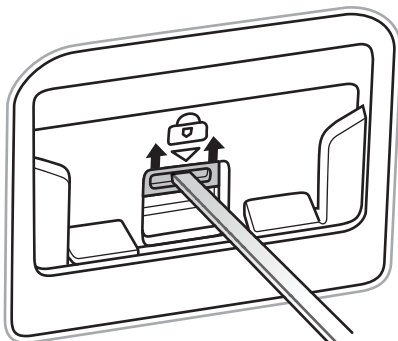
Figure 115: Unlock MSR

- 2 Press the two release buttons.

Figure 116: Remove MSR

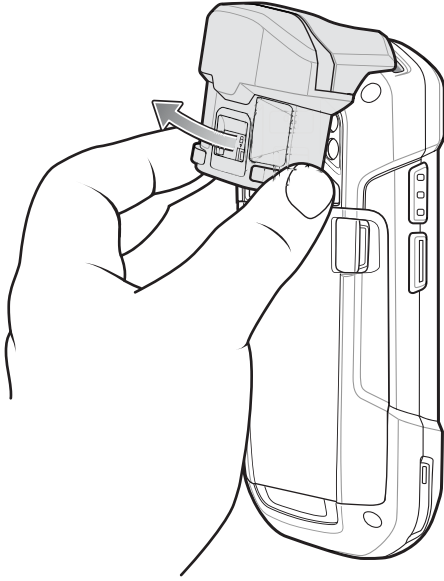

- 3 Rotate the MSR away from the TC70 and lift.

Reading Magnetic Stripe Cards

Use the integrated MSR to read magnetic stripe card.

Procedure:

- 1 Ensure that **MSR input** is enabled in DataWedge and the cursor is in a text field.
- 2 Grip TC70 firmly in one hand.
- 3 Hold magnetic stripe card firmly in the other hand.
- 4 Align the magnetic stripe on the card away from the display and swipe the card smoothly in either direction.

Figure 117: Swiping a Magnetic Stripe Card

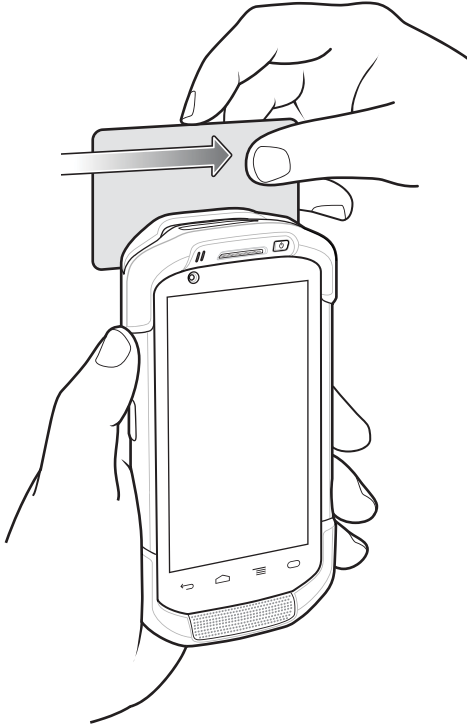

5 Depending upon the application, the captured data appears.

2.5 mm Audio Adapter

The 2.5 mm Audio Adapter snaps onto the back of the TC70 and removes easily when not in use. When attached to the TC70, the Audio Adapter allows a user to connect a wired headset to the TC70.

Attaching the 2.5 mm Audio Adapter

Procedure:

- 1 Align the top mounting points on the Audio Adapter with the mounting slots on the TC70.

Figure 118: Audio Adapter Installation

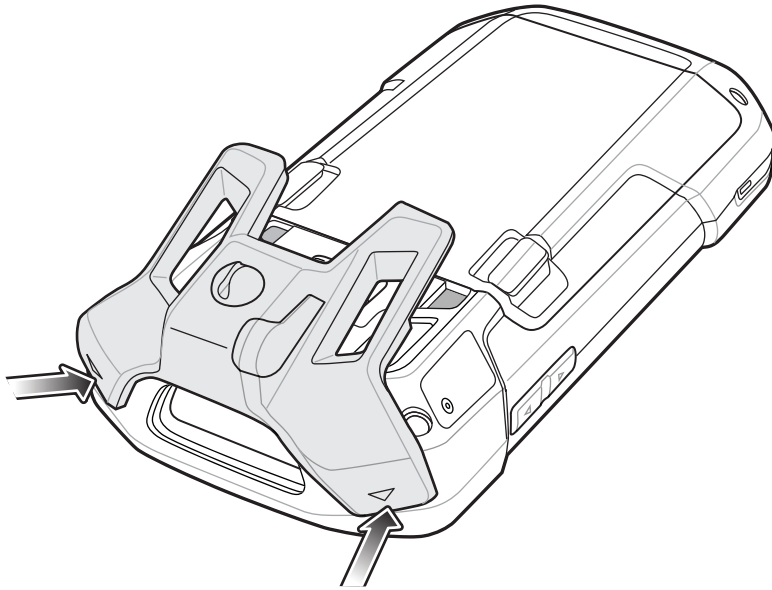

- 2 Rotate the Audio Adapter down and press down until it snaps into position.

Figure 119: Rotate Audio Adapter onto TC70

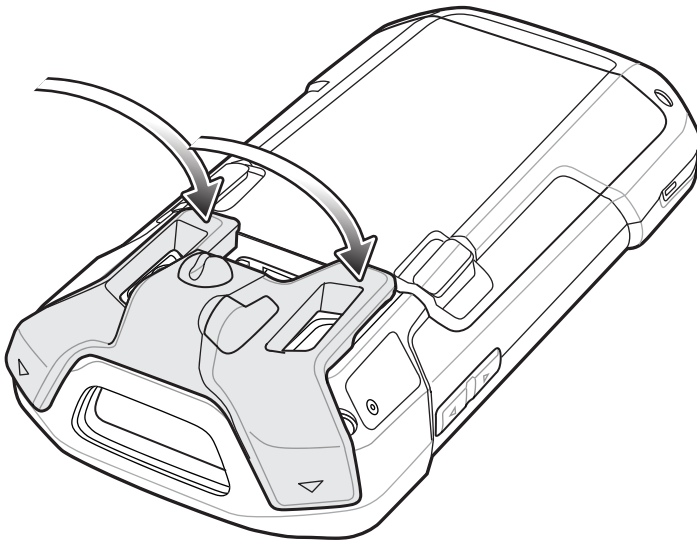

Connecting a Headset to the Audio Adapter

Procedure:

- 1 Lift the rubber plug from the audio jack.
- 2 Insert the headset plug into the jack on the Audio Adapter.

Figure 120: Connect Headset to Audio Adapter

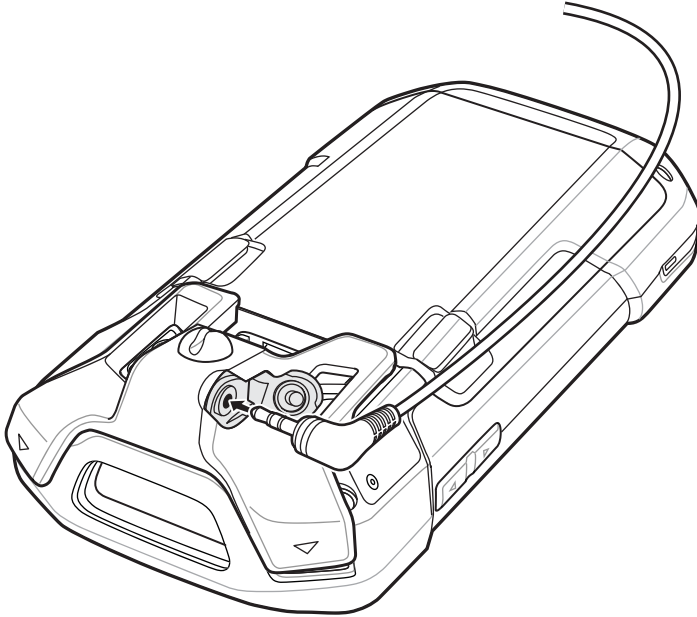

- 3 Press the headset wire into the wire holder on the Audio Adapter.

Figure 121:

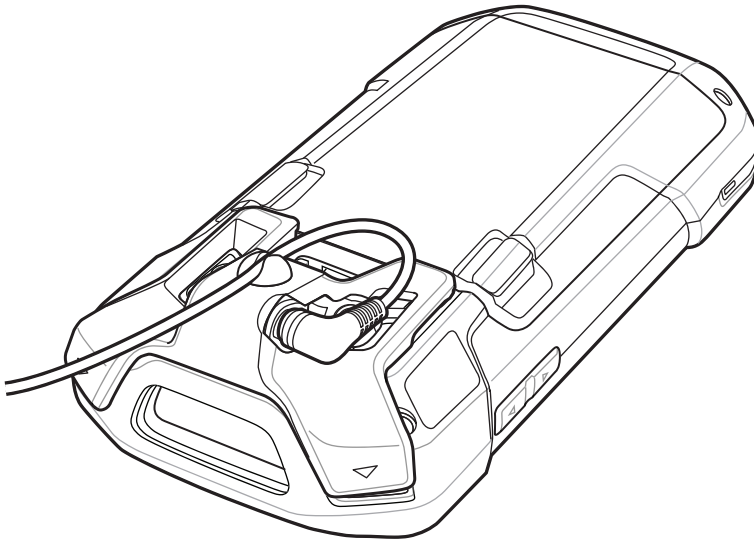

Device with Audio Adapter in Holster

When using the TC70 and the audio adapter in a holster, ensure that the display faces in and the headset cable is securely attached to the audio adapter.

Figure 122: Device with Audio Adapter in Holster

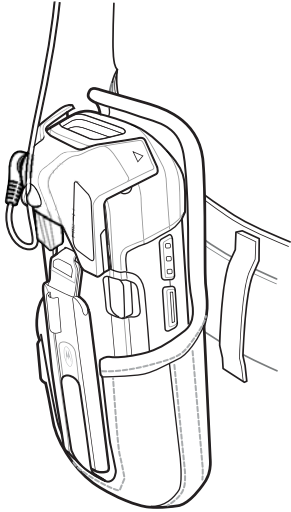

Removing the 2.5 mm Audio Adapter

Procedure:

- 1 Disconnect headset plug from 2.5 mm Audio Adapter.
- 2 Lift the bottom of the Audio Adapter away from the TC70.

Figure 123: Remove Audio Adapter from TC70

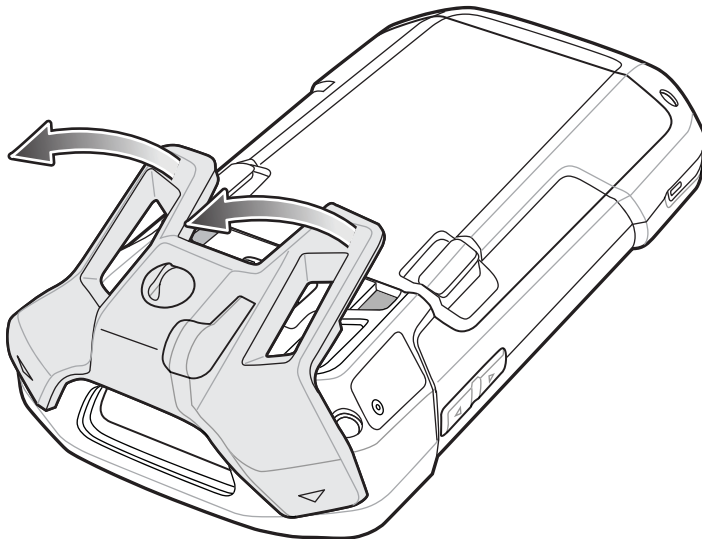

- 3 Remove Audio Adapter from the TC70.

3.5 mm Audio Adapter

The 3.5 mm Audio Adapter snaps onto the back of the TC70 and removes easily when not in use. When attached to the TC70, the 3.5 mm Audio Adapter allows a user to connect a wired headset to the TC70.

Attaching the 3.5 mm Audio Adapter

Procedure:

- 1 Align the top mounting points on the 3.5 mm Audio Adapter with the mounting slots on the TC70.

Figure 124: Audio Adapter Installation

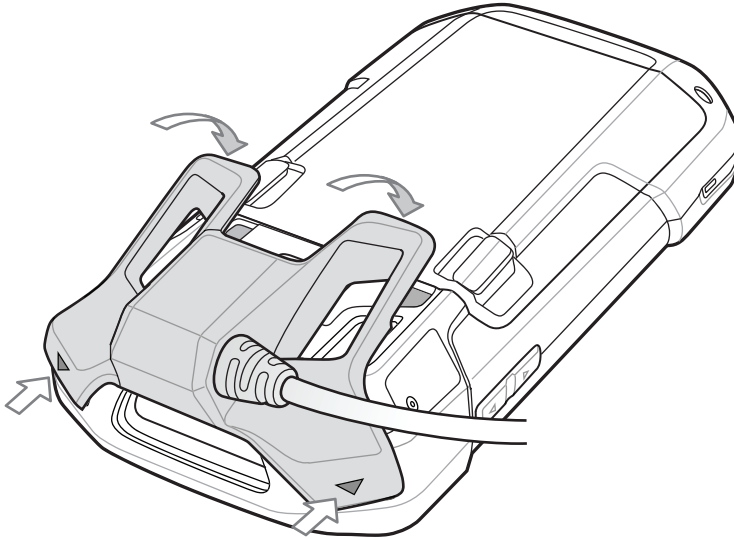

- 2 Rotate the Audio Adapter down and press down until it snaps into position.

Connecting a Headset to the 3.5 mm Audio Adapter

Procedure:

- 1 Connect the Quick Disconnect connect of the headset to the Quick Disconnect connector of the 3.5 mm Quick Disconnect Adapter Cable.

Figure 125: Connect Headset to Adapter Cable

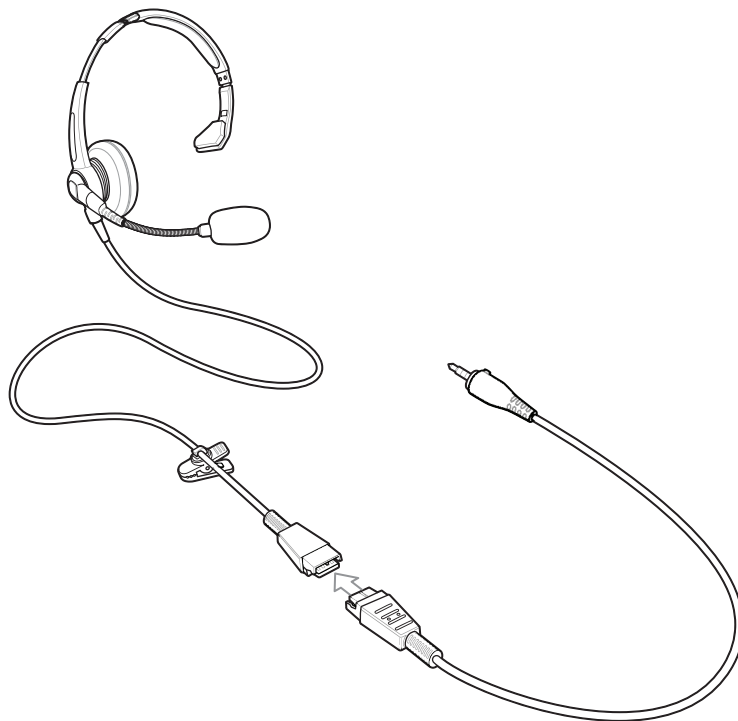

- 2 Connect the audio jack of the 3.5 mm Quick Disconnect Adapter Cable to the 3.5 mm Audio Adapter.

Figure 126: Connect Adapter Cable to Audio Adapter

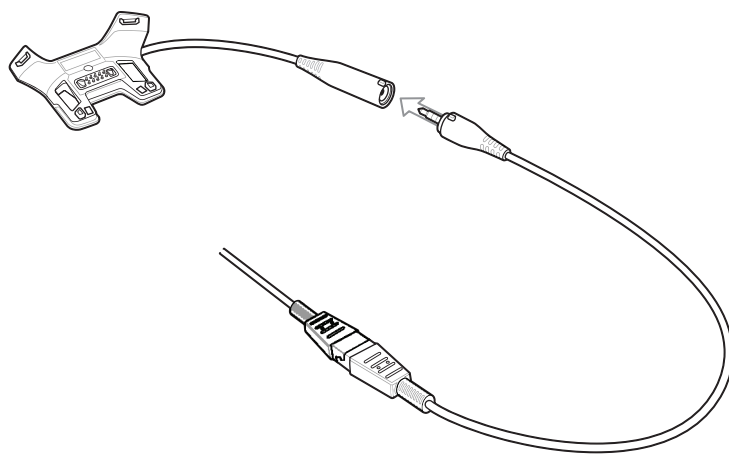

Device with 3.5 mm Audio Adapter in Holster

When using the TC70 and the audio adapter in a holster, ensure that the display faces in and the headset cable is securely attached to the audio adapter.

Figure 127: Device with 3.5 mm Audio Adapter in Holster

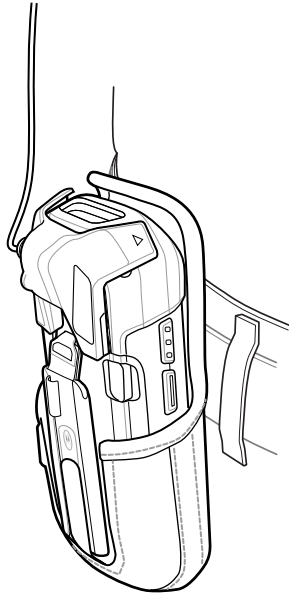

Removing the 3.5 mm Audio Adapter

Procedure:

- 1 Disconnect headset plug from 3.5 mm Audio Adapter.
- 2 Lift the bottom of the Audio Adapter away from the TC70.

Figure 128: Remove Audio Adapter from TC70

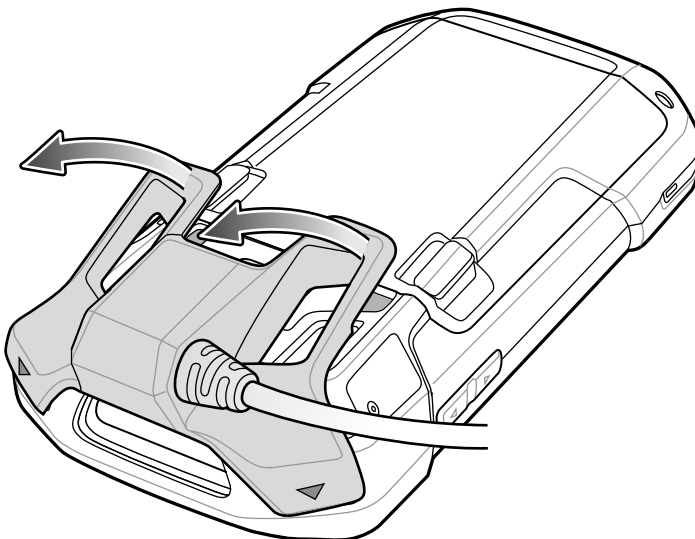

- 3 Remove Audio Adapter from the TC70.

Snap-On USB Cable

The Snap-On USB Cable snaps on to the back of the TC70 and removes easily when not in use. When attached to the TC70, the Snap-On USB Cable allows the TC70 to transfer data to a host computer and provide power for charging the TC70.

Connecting to TC70

Procedure:

- 1 Align the top mounting points on the cable with the mounting slots on the TC70.

Figure 129: Cable Installation

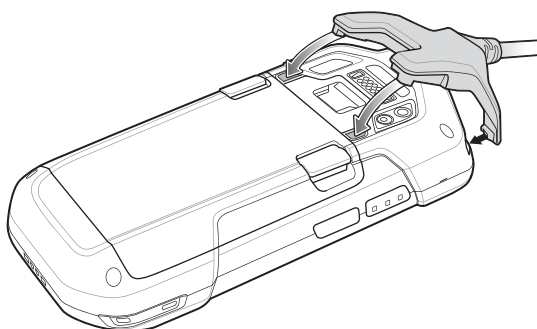

- 2 Rotate the cable down and press until it snaps into place. Magnetics hold the cable to the TC70.

Figure 130: Cable Attached to TC70

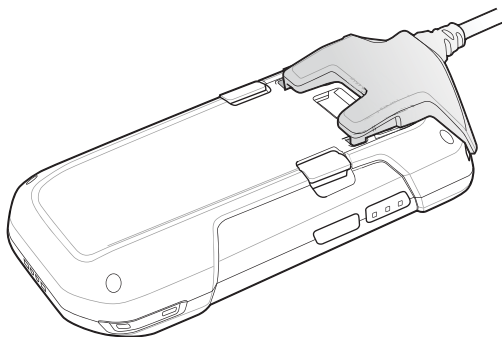

USB Communication

Procedure:

- 1 Connect the Snap-On USB Cable to the TC70.

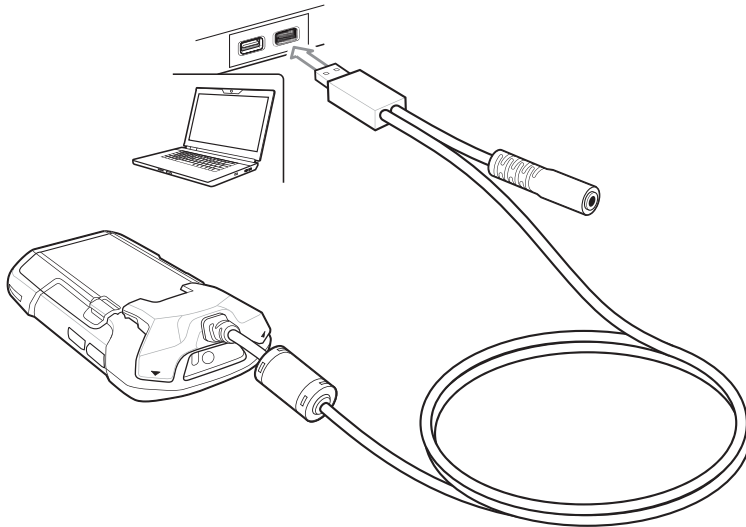
Figure 131: Cable Removed from TC70

- 2 Connect the USB connector of the cable to a host computer.

Charging the TC70

Procedure:

- 1 Connect the Snap-On USB Cable to the TC70.
- 2 Connect the power supply to the Snap-On USB Cable

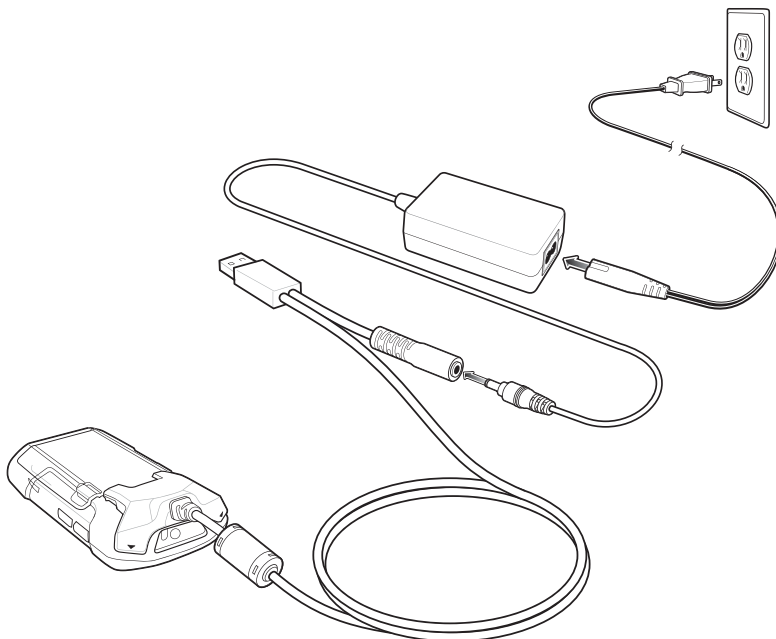
Figure 132: Power Setup

- 3 Connect to the power supply to an AC outlet.

Disconnecting from TC70

Procedure:

- 1 Press down on the cable.

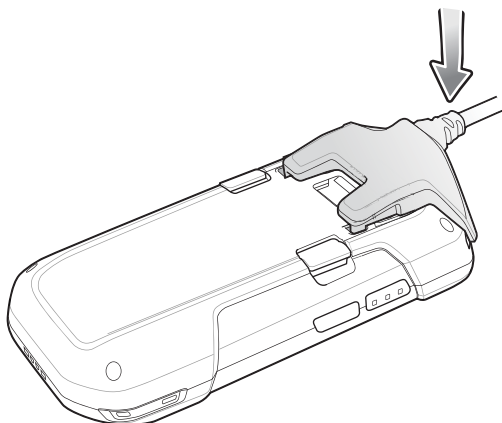
Figure 133: Press Down on Cable

- 2 Rotate away from the TC70. The magnetics release the cable from the TC70.

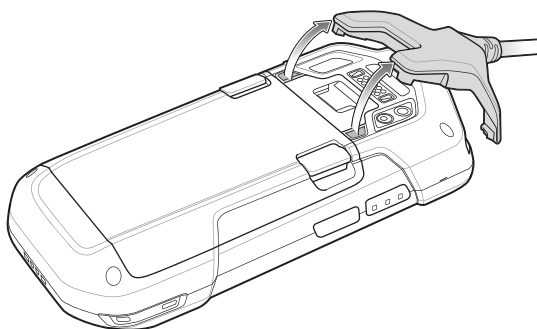
Figure 134: Remove Cable from TC70

Battery Charging

Main Battery Charging

The device's Charging/Notification LED indicates the status of the battery charging in the device.

The 4,620 mAh battery fully charges in less than six hours at room temperature.

Charging Temperature

Charge batteries in temperatures from 0 °C to 40 °C (32 °F to 104 °F). The device always performs battery charging in a safe and intelligent manner. At higher temperatures (e.g. approximately +37 °C (+98 °F)) the device may for small periods of time alternately enable and disable battery charging to keep the battery at acceptable temperatures. The device indicates when charging is disabled due to abnormal temperatures via its LED.

Charging Cable Cup

This section describes how to use the Charging Cable Cup to charge the TC70.

Charging the TC70

Procedure:

- 1 Insert the TC70 into the cup of the Charging Cable Cup.

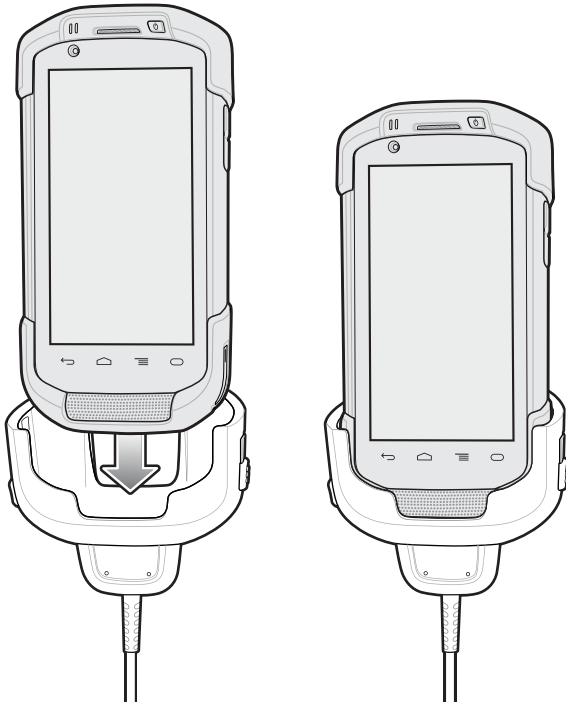
Figure 135: TC70 Charging

- 2 Ensure the TC70 is seated properly.
- 3 Slide the two yellow locking tabs up to lock the cable to the TC70.

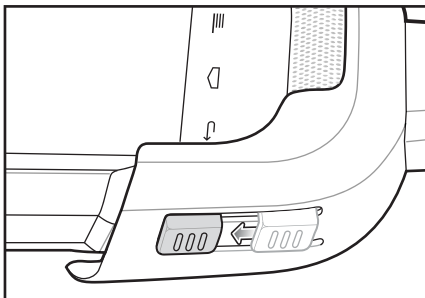
Figure 136: Lock Cable Cup

- 4 Connect the power supply to the Charging Cable Cup and to a power source.

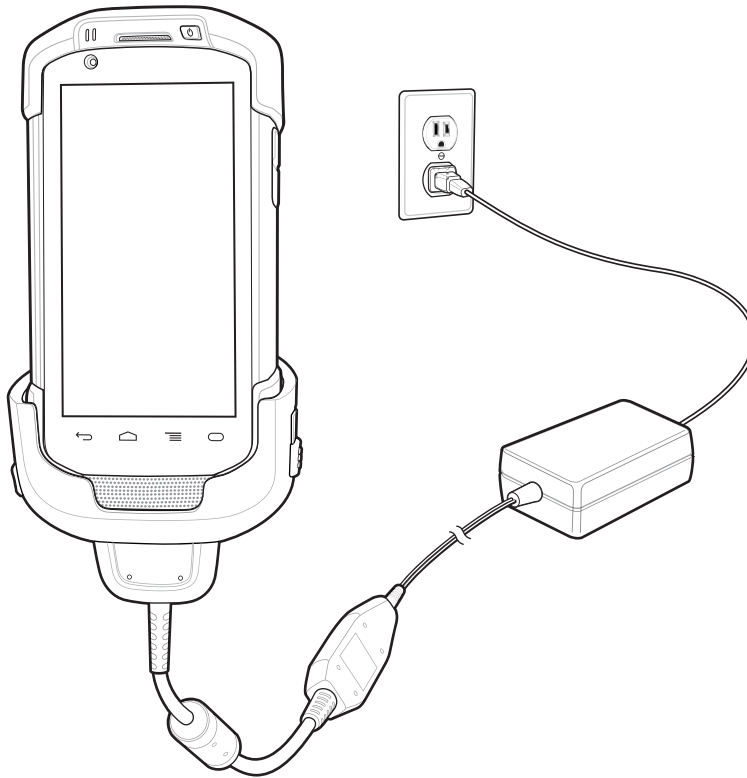
Figure 137: Connect Cable to Power Supply

Battery Charging

Main Battery Charging

The device's Charging/Notification LED indicates the status of the battery charging in the device.

The 4,620 mAh battery fully charges in less than six hours at room temperature.

Charging Temperature

Charge batteries in temperatures from 0 °C to 40 °C (32 °F to 104 °F). The device always performs battery charging in a safe and intelligent manner. At higher temperatures (e.g. approximately +37 °C (+98 °F)) the device may for small periods of time alternately enable and disable battery charging to keep the battery at acceptable temperatures. The device indicates when charging is disabled due to abnormal temperatures via its LED.

Snap-On DEX Cable

The Snap-On DEX Cable snaps on to the back of the TC70 and removes easily when not in use. When attached to the TC70, the Snap-On DEX Cable provides electronic data exchange with devices such as vending machines.

Connecting to TC70

Procedure:

- 1 Align the top mounting points on the cable with the mounting slots on the TC70.

Figure 138: Cable Installation

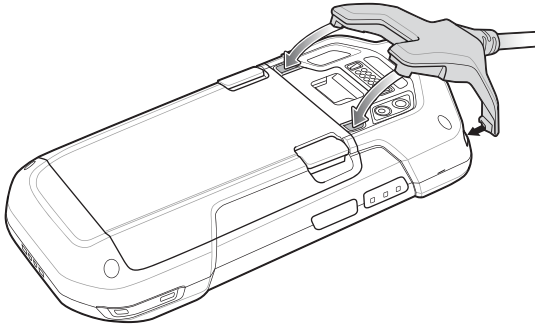

- 2 Rotate the cable down and press until it snaps into place. Magnetics hold the cable to the TC70.

Figure 139: Cable Attached to TC70

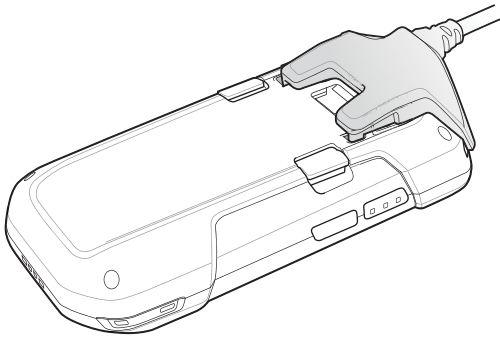

DEX Communication

Procedure:

- 1 Connect the Snap-On DEX Cable to the TC70.
- 2 Connect the DEX connector of the cable to a device such as a vending machine.

Figure 140: DEX Cable Connection

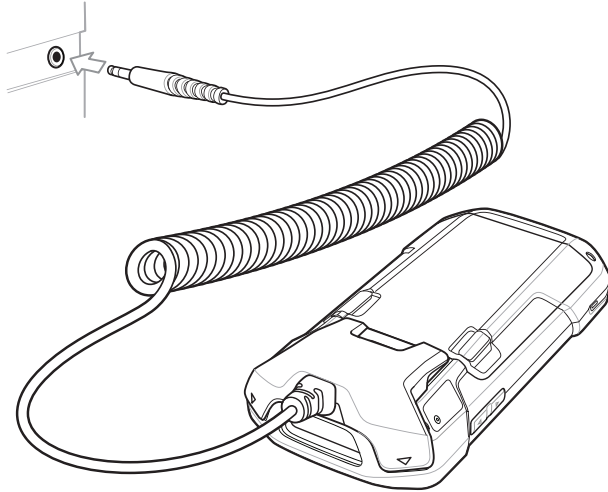

Disconnecting from TC70

Procedure:

- 1 Press down on the cable.

Figure 141: Press Down on Cable

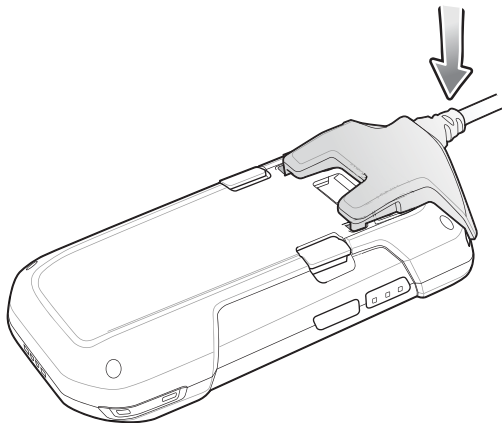

- 2 Rotate away from the TC70. The magnetics release the cable from the TC70.

Figure 142: Remove Cable from TC70

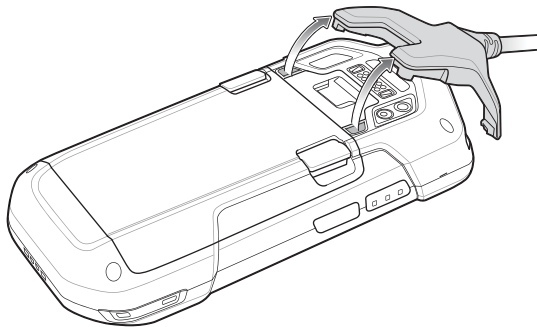

Trigger Handle

The Trigger Handle adds a gun-style handle with a scanning trigger to the device. It increases comfort when using the device in scan-intensive applications for extended periods of time.

Figure 143: Trigger Handle

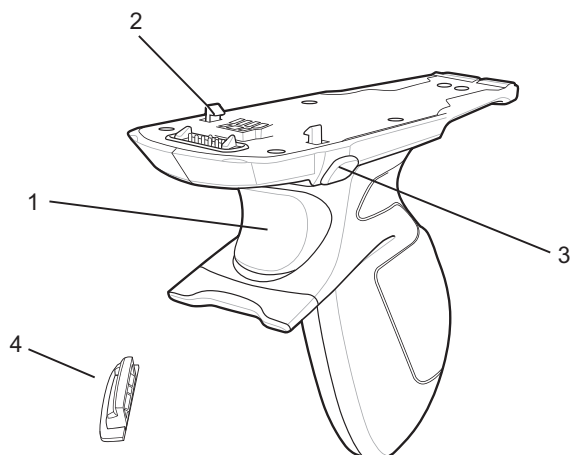

1	Trigger
2	Latch
3	Release button
4	Trigger Handle Plate

Installing the Trigger Handle Plate

Procedure:

- 1 Press and hold the **Power** button until the menu appears.
- 2 Touch **Power off**.
- 3 Touch **OK**.
- 4 Press in the two battery latches.
- 5 Lift the battery from the device.
- 6 Remove the hand strap filler plate from the hand strap slot. Store the hand strap filler plate in a safe place for future replacement.

Figure 144: Remove Hand Strap Plate

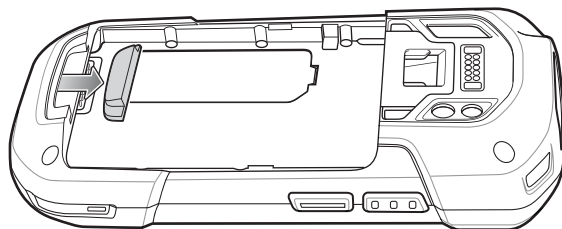

- 7 Insert the replacement hand strap plate into the hand strap slot.

Figure 145: Insert Trigger Handle Plate

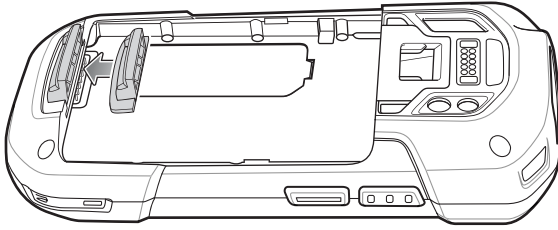

- 8 Insert the battery, bottom first, into the battery compartment in the back of the device.
- 9 Rotate the top of the battery into the battery compartment.
- 10 Press the battery down into the battery compartment until the battery release latches snap into place.

Inserting the Device into the Trigger Handle

Procedure:

- 1 Align the back of the Trigger handle with the Trigger Mounting Plate.

Figure 146: Connect Device to Trigger Handle

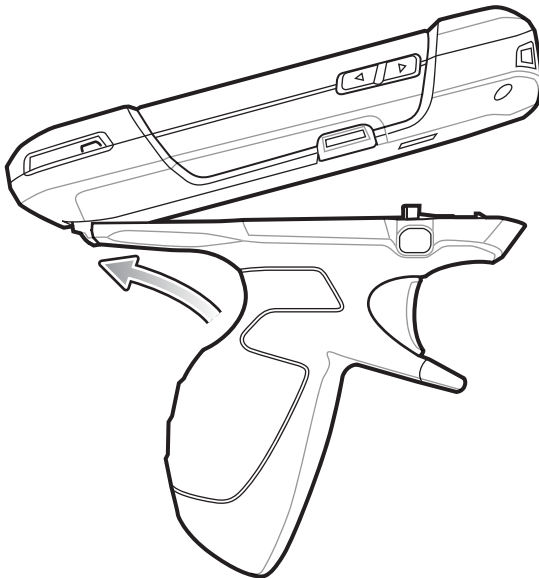

- 2 Press the two release latches.
- 3 Rotate the device down and press down until it snaps into place.

Figure 147: Rotate Device onto Trigger Handle

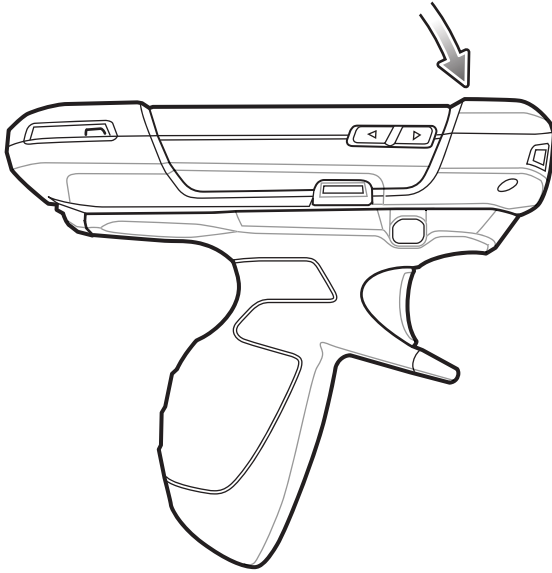

Removing the Device from the Trigger Handle

Procedure:

- 1 Press both Trigger Handle release latches.

Figure 148: Press Release Latches

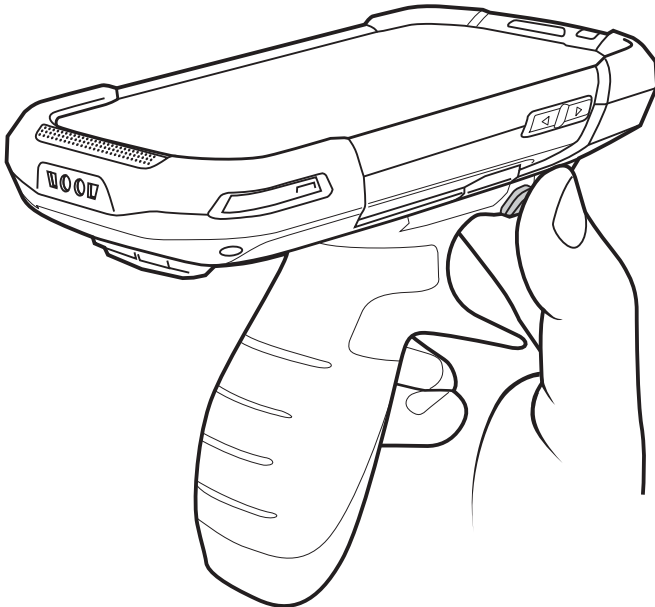

- 2 Rotate the device up and remove from the Trigger handle.
- 3 Rotate the device down and press down until it snaps into place.

Figure 149: Rotate Device onto Trigger Handle

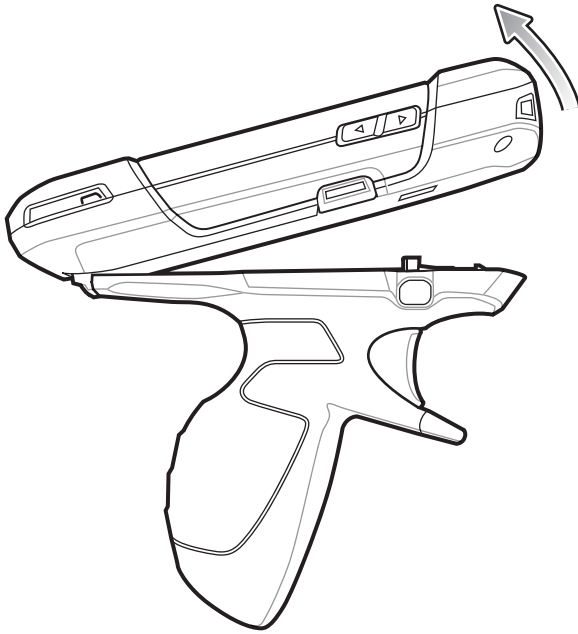

Chapter 7

Maintenance and Troubleshooting

This chapter includes instructions on cleaning and storing the device, and provides troubleshooting solutions for potential problems during operation.

Maintaining the TC70

For trouble-free service, observe the following tips when using the TC70:

- Do not scratch the screen of the TC70. When working with the TC70, use the supplied stylus or plastic-tipped pens intended for use with a touch-sensitive screen. Never use an actual pen or pencil or other sharp object on the surface of the TC70 screen.
- The touch-sensitive screen of the TC70 is glass. Do not drop the TC70 or subject it to strong impact.
- Protect the TC70 from temperature extremes. Do not leave it on the dashboard of a car on a hot day, and keep it away from heat sources.
- Do not store or use the TC70 in any location that is dusty, damp, or wet.
- Use a soft lens cloth to clean the TC70. If the surface of the TC70 screen becomes soiled, clean it with a soft cloth moistened with a diluted window-cleaning solution.
- Periodically replace the rechargeable battery to ensure maximum battery life and product performance. Battery life depends on individual usage patterns.

Battery Safety Guidelines

- The area in which the units are charged should be clear of debris and combustible materials or chemicals. Particular care should be taken where the device is charged in a non commercial environment.
- Follow battery usage, storage, and charging guidelines found in this guide.
- Improper battery use may result in a fire, explosion, or other hazard.
- To charge the mobile device battery, the battery and charger temperatures must be between +32 °F and +104 °F (0 °C and +40 °C)
- Do not use incompatible batteries and chargers. Use of an incompatible battery or charger may present a risk of fire, explosion, leakage, or other hazard. If you have any questions about the compatibility of a battery or a charger, contact the Global Customer Support Center.
- For devices that utilize a USB port as a charging source, the device shall only be connected to products that bear the USB-IF logo or have completed the USB-IF compliance program.
- Do not disassemble or open, crush, bend or deform, puncture, or shred.
- Severe impact from dropping any battery-operated device on a hard surface could cause the battery to overheat.
- Do not short circuit a battery or allow metallic or conductive objects to contact the battery terminals.
- Do not modify or remanufacture, attempt to insert foreign objects into the battery, immerse or expose to water or other liquids, or expose to fire, explosion, or other hazard.
- Do not leave or store the equipment in or near areas that might get very hot, such as in a parked vehicle or near a radiator or other heat source. Do not place battery into a microwave oven or dryer.

- Battery usage by children should be supervised.
- Please follow local regulations to properly dispose of used re-chargeable batteries.
- Do not dispose of batteries in fire.
- In the event of a battery leak, do not allow the liquid to come in contact with the skin or eyes. If contact has been made, wash the affected area with large amounts of water and seek medical advice.
- If you suspect damage to your equipment or battery, contact the Customer Support to arrange for inspection.

Cleaning Instructions

**Caution:**

Always wear eye protection.

Read warning label on compressed air and alcohol product before using.

If you have to use any other solution for medical reasons please contact the Global Customer Support Center for more information.



Warning: Avoid exposing this product to contact with hot oil or other flammable liquids. If such exposure occurs, unplug the device and clean the product immediately in accordance with these guidelines.

Approved Cleanser Active Ingredients

100% of the active ingredients in any cleaner must consist of one or some combination of the following: isopropyl alcohol, bleach/sodium hypochlorite, hydrogen peroxide or mild dish soap.

Harmful Ingredients

The following chemicals are known to damage the plastics on the device and should not come in contact with the device: ammonia solutions, compounds of amines or ammonia; acetone; ketones; ethers; aromatic and chlorinated hydrocarbons; aqueous or alcoholic alkaline solutions; ethanolamine; toluene; trichloroethylene; benzene; carbolic acid and TB-lysoform.

Cleaning Instructions

Do not apply liquid directly to the device. Dampen a soft cloth or use pre-moistened wipes. Do not wrap the device in the cloth or wipe, but gently wipe the unit. Be careful not to let liquid pool around the display window or other places. Allow the unit to air dry before use.

Special Cleaning Notes

Many vinyl gloves contain phthalate additives, which are often not recommended for medical use and are known to be harmful to the housing of the device. The device should not be handled while wearing vinyl gloves containing phthalates, or before hands are washed to remove contaminant residue after gloves are removed. If products containing any of the harmful ingredients listed above are used prior to handling the device, such as hand sanitizer that contain ethanolamine, hands must be completely dry before handling the device to prevent damage to the plastics.

Cleaning Materials Required

- Alcohol wipes
- Lens tissue
- Cotton-tipped applicators
- Isopropyl alcohol
- Can of compressed air with a tube.

Cleaning Frequency

The cleaning frequency is up to the customer's discretion due to the varied environments in which the mobile devices are used. They may be cleaned as frequently as required, but it is advisable to clean the camera window periodically when used in dirty environments to ensure optimum performance.

Cleaning the TC70

Housing

Using the alcohol wipes, wipe the housing including buttons.

Display

The display can be wiped down with the alcohol wipes, but care should be taken not to allow any pooling of liquid around the edges of the display. Immediately dry the display with a soft, non-abrasive cloth to prevent streaking.

Camera and Exit Window

Wipe the camera and exit window periodically with a lens tissue or other material suitable for cleaning optical material such as eyeglasses.

Connector Cleaning

To clean the connectors:

Procedure:

- 1 Remove the main battery from mobile computer.
- 2 Dip the cotton portion of the cotton-tipped applicator in isopropyl alcohol.
- 3 Rub the cotton portion of the cotton-tipped applicator back-and-forth across the connector. Do not leave any cotton residue on the connector.
- 4 Repeat at least three times.
- 5 Use the cotton-tipped applicator dipped in alcohol to remove any grease and dirt near the connector area.
- 6 Use a dry cotton-tipped applicator and repeat steps 4 through 6.



Caution: Do not point nozzle at yourself and others, ensure the nozzle or tube is away from your face.

- 7 Spray compressed air on the connector area by pointing the tube/nozzle about ½ inch away from the surface.
- 8 Inspect the area for any grease or dirt, repeat if required.

Cleaning Cradle Connectors

To clean the connectors on a cradle:

Procedure:

- 1 Remove the DC power cable from the cradle.
- 2 Dip the cotton portion of the cotton-tipped applicator in isopropyl alcohol.
- 3 Rub the cotton portion of the cotton-tipped applicator along the pins of the connector. Slowly move the applicator back-and-forth from one side of the connector to the other. Do not leave any cotton residue on the connector.
- 4 All sides of the connector should also be rubbed with the cotton-tipped applicator.



Caution: Do not point nozzle at yourself and others, ensure the nozzle or tube is pointed away from your face.

- 5 Spray compressed air in the connector area by pointing the tube/nozzle about ½ inch away from the surface.
- 6 Remove any lint left by the cotton-tipped applicator.

- 7 If grease and other dirt can be found on other areas of the cradle, use a lint-free cloth and alcohol to remove.
- 8 Allow at least 10 to 30 minutes (depending on ambient temperature and humidity) for the alcohol to air dry before applying power to cradle.
If the temperature is low and humidity is high, longer drying time is required. Warm temperature and dry humidity requires less drying time.

Troubleshooting

The following tables provides typical problems that might arise and the solution for correcting the problem.

TC70

Table 20: Troubleshooting the TC70

Problem	Cause	Solution
When pressing the power button the TC70 does not turn on.	Battery not charged.	Charge or replace the battery in the TC70.
	Battery not installed properly.	Install the battery properly.
	System crash.	Perform a reset.
When pressing the power button the TC70 does not turn on but two LEDs blink.	Battery charge is at a level where data is maintained but battery should be re-charged.	Charge or replace the battery in the TC70.
Battery did not charge.	Battery failed.	Replace battery. If the TC70 still does not operate, perform a reset.
	TC70 removed from cradle while battery was charging.	Insert TC70 in cradle. The 4,620 mAh battery fully charges in less than six hours at room temperature.
	Extreme battery temperature.	Battery does not charge if ambient temperature is below 0°C (32°F) or above 40°C (104°F).
Cannot see characters on display.	TC70 not powered on.	Press the Power button.
During data communication with a host computer, no data transmitted, or transmitted data was incomplete.	TC70 removed from cradle or disconnected from host computer during communication.	Replace the TC70 in the cradle, or reattach the communication cable and re-transmit.
	Incorrect cable configuration.	See the system administrator.
	Communication software was incorrectly installed or configured.	Perform setup.
During data communication over Wi-Fi, no data transmitted, or	Wi-Fi radio is not on.	Turn on the Wi-Fi radio.
	You moved out of range of an access point.	Move closer to an access point.

Table continued...



Problem	Cause	Solution
transmitted data was incomplete.		
During data communication over Bluetooth, no data transmitted, or transmitted data was incomplete.	Bluetooth radio is not on.	Turn on the Bluetooth radio.
	You moved out of range of another Bluetooth device.	Move within 10 meters (32.8 feet) of the other device.
No sound.	Volume setting is low or turned off.	Adjust the volume.
TC70 shuts off.	TC70 is inactive.	The display turns off after a period of inactivity. Set this period to 15 seconds, 30 seconds, 1, 2, 5, 10 or 30 minutes.
	Battery is depleted.	Replace the battery.
Tapping the window buttons or icons does not activate the corresponding feature.	The device is not responding.	Reset the device.
A message appears stating that the TC70 memory is full.	Too many files stored on the TC70.	Delete unused memos and records. If necessary, save these records on the host computer (or use an SD card for additional memory).
	Too many applications installed on the TC70.	Remove user-installed applications on the TC70 to recover memory. Select  >  Apps > Downloaded . Select the unused program and tap Remove .
The TC70 does not decode with reading bar code.	Scanning application is not loaded.	Load a scanning application on the TC70 or enable DataWedge. See the system administrator.
	Unreadable bar code.	Ensure the symbol is not defaced.
	Distance between exit window and bar code is incorrect.	Place the TC70 within proper scanning range.
	TC70 is not programmed for the bar code.	Program the TC70 to accept the type of bar code being scanned. Refer to the EMDK or DataWedge application.
	TC70 is not programmed to generate a beep.	If the TC70 does not beep on a good decode, set the application to generate a beep on good decode.
	Battery is low.	If the scanner stops emitting a laser beam upon a trigger press, check the battery level. When the battery is low, the scanner shuts off before the TC70 low battery condition notification. Note: If the scanner is still not reading symbols, contact the distributor or the Global Customer Support Center.
TC70 cannot find any Bluetooth devices nearby.	Too far from other Bluetooth devices.	Move closer to the other Bluetooth device(s), within a range of 10 meters (32.8 feet).
	The Bluetooth device(s) nearby are not turned on.	Turn on the Bluetooth device(s) to find.
	The Bluetooth device(s) are not in discoverable mode.	Set the Bluetooth device(s) to discoverable mode. If needed, refer to the device's user documentation for help.

Table continued...

Problem	Cause	Solution
Cannot unlock TC70.	User enters incorrect password.	If the user enters an incorrect password eight times, the user is requested to enter a code before trying again. If the user forgot the password, contact system administrator.

Chapter

8

Technical Specifications

The following sections provide technical specification for the device.

TC70

Table 21: TC70 Technical Specifications

Item	Description
Physical Characteristics	
Dimensions	Height: 161 mm (6.3 in.) Width: 84 mm (3.3 in.) Depth: 28 mm (1.1 in.)
Weight	376 g (13.3 oz)
Display	4.7 in. High Definition (1280 x 720); exceptionally bright image; optically bonded to touch panel
Touch Panel	Glass analog capacitive touch
Backlight	Light Emitting Diode (LED) backlight
Battery Pack	Rechargeable Lithium Ion 3.7V, 4,620 mAh battery
Expansion Slot	User accessible 32 GB microSD slot with SDHC and SDXC support
Connection Interface	Universal Serial Bus (USB) 2.0 High Speed (host and client)
Notification	Audible tone plus multi-color LEDs, vibration
Voice and Audio	Three microphone support with noise cancellation; vibrate alert; speaker; Bluetooth wireless headset support
Performance Characteristics	
CPU	1.7 GHz multi-core.
Operating System	Android-based AOSP V4.4.2 or V4.4.3.
Memory	1 GB RAM/8 GB Flash
Output Power	USB - 5 VDC @ 500 mA max
User Environment	
Operating Temperature	-20 °C to 50 °C (-4 °F to 122 °F)
Storage Temperature	-40°C to 70°C (-40°F to 158°F)

Table continued...

Item	Description
Charging Temperature	0° C to 40° C (32°F to 104°F)
Humidity	5 to 85% non-condensing
Drop Specification	6 ft./1.8 m drop to concrete across full operating temperature range
Tumble	2,000 3.2 ft./1.0 m tumbles; meets and exceeds IEC tumble specifications
Electrostatic Discharge (ESD)	+/-20kVdc air discharge, +/-10kVdc direct discharge, +/-10kVdc indirect discharge
Sealing	IP67 per applicable IEC sealing specifications
Vibration	4 g's PK Sine (5 Hz to 2 kHz); 0.04g2/Hz Random (20 Hz to 2 kHz); 60 minute duration per axis, 3 axis
Thermal Shock	-40° C to 70° C (-40° F to 158° F) rapid transition
Interactive Sensor Technology (IST)	
Motion Sensor	3-axis accelerometer provides motion-sensing for dynamic screen orientation and power management
Light Sensor	Ambient light sensor to auto adjust display backlight brightness
Wireless LAN Data and Voice Communications	
Radio	IEEE® 802.11a/b/g/n/d/h/l
Data Rates Supported	5GHz: 802.11a/n - up to 150 Mbps 2.4GHz: 802.11b/g/n - up to 72.2 Mbps
Operating Channels	5 GHz: Chan 36 - 165 (5180 - 5825 MHz) 2.4 GHz: Chan 1 - 11 (2412 – 2462 MHz) – North America (FCC and IC) Chan 1 - 13 (2412 - 2472 MHz) – Rest of the World Actual operating channels/frequencies depend on regulatory rules and certification agency
Security	Security Modes: Legacy, WPA and WPA2 Encryption: WEP (40 and 104 bit), TKIP and AES Authentication: TLS, TTLS (MS-CHAP), TTLS (MS-CHAP v2), TTLS (PAP), PEAP (MS-CHAP v2), PEAP (GTC), FAST (MS-CHAP v2), FAST (GTC), LEAP. Fast Roam: PMKID, OKC, CCKM
Voice Communications	Voice-over-IP ready, Wi-Fi™-certified, IEEE 802.11a/b/g/n direct sequence wireless LAN, Wi-Fi Multimedia™ (WMM)
Wireless PAN Data and Voice Communications	
Bluetooth	Bluetooth v4.0 Low Energy
Data Capture Specifications	
2D Imager	SE4750-SR – 1D and 2D bar codes.
Near Field Communications (NFC)	Supports ISO 14443 Type A & B, FeliCa, and ISO 15963 tags.

Table continued...

Item	Description
Communication and Messaging	
Workforce Connect Push-to-Talk Express Client (included) for instant push-to-talk communications right out of the box WorkForce Connect Voice Client* (sold separately).	
2D Imager Engine (SE4750-SR) Specifications	
Field of View	Horizontal - 48.0° Vertical - 36.7°
Image Resolution	1280 horizontal X 960 vertical pixels
Roll	360°
Pitch Angle	+/- 60° from normal
Skew Tolerance	+/- 60° from normal
Ambient Light	Sunlight: 10,000 ft. candles (107,639 lux)
Focal Distance	From front of engine: 17.7 cm (7.0 in.)
Laser Aiming Element	Visible Laser Diode (VLD): 655 nm +/- 10 nm Central Dot Optical Power: 0.6 mW (typical) Pattern Angle: 48.0° horizontal, 38.0° vertical
Illumination System	LEDs: Warm white LED Pattern Angle: 80° at 505 intensity
Camera Specifications	
Resolution	Rear: 8 Mega pixel auto focus with flash Front: 1.3 Mega pixel fixed focus

Table 22: Data Capture Supported Symbologies

Item	Description
1D Bar Codes	Code 128, EAN-8, EAN-13, GS1 DataBar Expanded, GS1 128, GS1 DataBar Coupon, UP-CA, Interleaved 2 of 5, UPC Coupon Code
2D Bar Codes	PDF-417, QR Code



Zebra Technologies Corporation
3 Overlook Point
Lincolnshire IL, 60069 U.S.A.
<http://www.zebra.com>

Zebra and the stylized Zebra head are trademarks of ZIH Corp., registered in many jurisdictions worldwide. The Symbol logo is a registered trademark of Symbol Technologies, Inc., a Zebra Technologies company. All other trademarks are the property of their respective owners.
© 2016 Symbol Technologies LLC. All rights reserved.

